

DR[®] PRO-21SP BATTERY LAWN MOWER

SAFETY & OPERATING INSTRUCTIONS



Serial No. _____

Order No. _____

DR Power Equipment
Toll-free phone: 1-800-DR-OWNER (376-9637)
Fax: 1-802-877-1213
Website: www.DRpower.com

WARNING

Read and understand this manual and all instructions before operating the DR PRO-21SP Battery Lawn Mower.

Table of Contents

Chapter 1: General Safety Rules..... 3

Chapter 2: Setting Up the DR PRO-21SP Battery Lawn Mower 7

Chapter 3: Operating the DR PRO-21SP Battery Lawn Mower..... 10

Chapter 4: Maintaining the DR PRO-21SP Battery Lawn Mower..... 13

Chapter 5: Troubleshooting 17

Chapter 6: Parts Lists and Schematic Diagrams..... 19

Conventions used in this manual

⚠ WARNING

This indicates a hazardous situation, which, if not avoided, **could** result in death or serious injury.

⚠ CAUTION

This indicates a hazardous situation, which, if not avoided, **could** result in minor or moderate injury.

NOTICE

This information is important in the proper use of your machine. Failure to follow this instruction could result in damage to your machine or property.

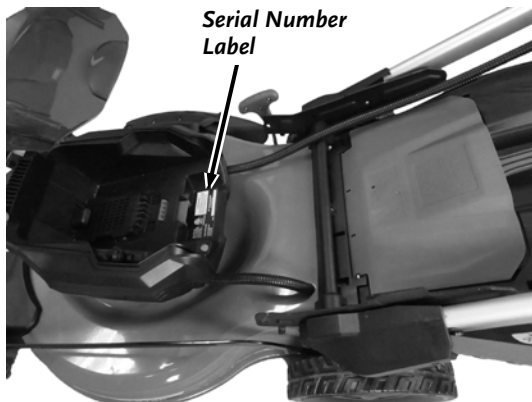

Figure 1

Serial Number and Order Number

A Serial Number is used to identify your machine and is located on the Serial Number Label on your machine. An Order Number is used to check and maintain your order history and is located on your packing slip. For your convenience and ready reference, enter the Serial Number and Order Number in the space provided on the front cover of this manual.

Additional Information and Potential Changes

DR Power Equipment reserves the right to discontinue, change, and improve its products at any time without notice or obligation to the purchaser. The descriptions and specifications contained in this manual were in effect at printing. Equipment described within this manual may be optional. Some illustrations may not be applicable to your machine.

Chapter 1: General Safety Rules

! WARNING

Read this safety & operating Instructions manual before you use the DR PRO-21SP Battery Lawn Mower. Become familiar with the operation and service recommendations to ensure the best performance from your machine. If you have any questions or need assistance, please contact us at www.DRpower.com or call toll-free 1-800-DR-OWNER (376-9637) and one of our Technical Support Representatives will be happy to help you.

Labels

Your DR PRO-21SP Battery Lawn Mower carries prominent labels as reminders for its proper and safe use. Shown below are copies of all the Safety and Information labels that appear on the equipment. Take a moment to study them and make a note of their location on your Mower as you set up and before you operate the unit. Replace damaged or missing safety and information labels immediately.



#41743



#41745

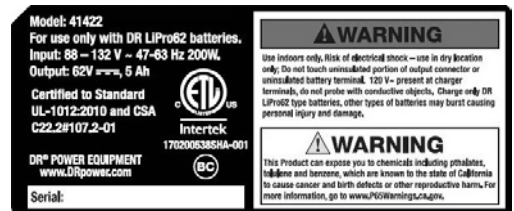

#41716 (Battery Charger)



#41719 (Battery)



#41720 (Battery)

Protecting Yourself and Those Around You

! WARNING

This is a high-powered machine, with moving parts operating with high energy. You must operate the machine safely. Unsafe operation can create a number of hazards for you, as well as anyone else in the nearby area. Always take the following precautions when using this machine:

- Keep in mind that the operator or user is responsible for accidents or hazards occurring to other people, their property, and themselves.
- Always wear protective goggles or safety glasses with side shields while using the Mower to protect your eyes from possible thrown debris.
- Avoid wearing loose clothing or jewelry, which can catch on moving parts.
- We recommend wearing gloves while using the Mower. Be sure your gloves fit properly and do not have loose cuffs or drawstrings.
- Wear shoes with non-slip treads when using your Mower. If you have safety shoes, we recommend wearing them. Do not use the machine while barefoot or wearing open sandals.
- Wear long pants while operating the Mower.
- Use ear protectors or ear plugs rated for at least 20 dba to protect your hearing.
- Keep bystanders at least 100 feet away from your work area at all times. Release the Blade Wire Trigger to stop the Blade when another person or pet approaches.

Safety for Children and Pets

WARNING

Tragic accidents can occur if the operator is not alert to the presence of children and pets. Children are often attracted to the machine and the mowing activity. *Never* assume that children will remain where you last saw them. Always follow these precautions:

- Keep children and pets at least 100 feet from the working area and ensure they are under the watchful care of a responsible adult.
- Be alert and turn the machine off if children or pets enter the work area.
- Never allow children to operate the Mower.
- Use extra care when approaching blind corners, shrubs, trees, or other objects that may block your view of a child or pet.

Handling the Battery Pack and Charger Safely

WARNING

- Always charge the Battery Pack indoors, never charge it the rain or in wet conditions.
- Use only the DR® 62V Charger with DR® 62V Battery Packs. Do not use the DR® 62V Charger with Battery Packs from other manufacturers or other DR® products. Use of a different Charger may cause a fire or explosion.
- Never attempt to alter or open the Battery Pack or Charger. There are no customer serviceable parts inside.
- Use normal household voltage (110 volts) when charging the Battery Pack. Plug the Charger Power Supply directly into the electrical outlet.
- Exercise care in handling the Battery Pack in order not to short-circuit it with conducting materials such as rings, bracelets, and keys. When short-circuited, the Battery Pack or conductor may overheat and cause burns.
- Electrolyte leakage from the Battery Pack can be harmful causing serious chemical burns if on the skin or in the eyes. Remove contaminated clothing and wash skin with soap and water. If electrolyte gets in your eyes, flush with cold water for at least 15 minutes and seek medical attention.
- Inhalation of vapors from a ruptured Battery Pack can cause respiratory irritation. In case of Inhalation of fumes get fresh air and seek medical attention.
- Never dispose of the Battery Pack in a fire, as the Battery Pack may explode.
- Never open or mutilate the Battery Pack; released materials are flammable.
- If fire or explosion occurs, do not breathe the fumes. A burning Battery Pack will create toxic fumes. Fire fighters should use self-contained breathing apparatus.
- NEVER USE WATER on a burning Battery. If possible, separate the Battery Pack from other flammable materials and use ABC rated fire extinguishers. Sand may be used to smother the fire if a fire extinguisher is not available.
- Do not ship damaged Battery Packs and be sure to use the original packaging materials when shipping Batteries and tools back to DR® Power Equipment if you decide you do not want them. Special labeling on the packaging is required because the Batteries are considered hazardous materials. Check with airlines before trying to check Lithium batteries with your baggage. New regulations are being considered that may restrict packaging and shipping of these Batteries as well as tools with Batteries installed.
- Please dispose of your used Battery Packs responsibly by recycling them, never throw away used Battery Packs in your household trash. Call your local Solid Waste Management District or your local waste handler to locate the collection site nearest you. Some collection sites recycle Battery Packs year-round; others collect them periodically.

Mower Blade Safety

DANGER

- Never place any part of your body near or under the housing while the Mower is running. The rotating Blades can lead to severe cuts or separation of parts of the body.
 - Never remove the collection bag while the unit is running.
 - Make sure that the collection bag is properly hung.
-

General Safety

WARNING

Operating this Mower safely is necessary to prevent or minimize the risk of death or serious injury. Unsafe operation can create a number of hazards for you. This Mower is capable of amputating hands and feet and throwing objects. Always take the following precautions when operating this Mower:

- Your Mower is a powerful tool, not a plaything. Exercise extreme caution at all times. The machine is designed to mow grass. Do not use it for any other purpose.
 - Ensure that the Mower is located flat on a level and clean area of lawn before starting.
 - Know how to stop the Mower quickly; see “Stopping the Blade” in chapter 3.
 - Never operate your unit on a slippery, wet, muddy, or icy surface. Exercise caution to avoid slipping or falling.
 - Always walk when mowing, never run.
 - Stop the blade when crossing surfaces other than grass, and when transporting the lawnmower to and from the area to be mowed.
 - See manufacturer’s instructions for proper operation and installation of accessories. Only use accessories approved by DR Power Equipment.
 - Never use the machine without ensuring that all guards and shields are in place.
 - Never, under any conditions, remove, bend, cut, fit, weld, or otherwise alter standard parts on the Mower. This includes all shields and guards. Modifications to your machine could cause personal injuries and property damage and will void your warranty.
 - Clear the area of objects such as rocks, wire, toys, etc., which could be thrown by the blade and cause injury.
 - Keep hands and feet clear of the discharge opening at all times and only operate the Mower from the operator position behind the handlebars.
 - Allow only one person to operate the Mower at any time.
 - Never direct discharged material toward anyone. Avoid discharging material against a wall or obstruction. Material may ricochet back toward the operator.
 - Do not pull machine backward unless absolutely necessary. Always look down and behind before and while moving backward.
 - If the machine should start making an unusual noise or vibration, stop the Blade, remove the safety key, then inspect for damage. Vibration is generally a warning of trouble. Check for damaged parts and clean, repair and/or replace as necessary.
 - Never tamper with safety devices. Check their proper operation regularly.
 - Before performing any maintenance procedure or inspection, stop the Blade and remove the safety key.
 - Never allow people who are unfamiliar with these instructions to use the Mower. Allow only responsible individuals who are familiar with these rules of safe operation to use your machine.
 - Never overload or attempt to mow material beyond the manufacturer’s recommendation. Personal injury or damage to the machine could result.
 - While using the Mower, don't hurry or take things for granted. When in doubt about the equipment or your surroundings, stop the machine and take the time to look things over.
 - Never operate the machine when under the influence of alcohol, drugs, or medication.
 - Use the machine only in daylight.
 - Keep all nuts and bolts tight and keep the equipment in good operating condition.
-

California Proposition 65

WARNING

This Product can expose you to chemicals including phthalates, toluene and benzene, which are known to the state of California to cause cancer and birth defects or other reproductive harm. For more information, go to www.P65Warnings.ca.gov.

A Note to All Users

No list of warnings and cautions can be all-inclusive. If situations occur that are not covered by this manual, the operator must apply common sense and operate this DR PRO-21SP Battery Lawn Mower in a safe manner. Contact us at www.DRpower.com or call 1-800-DR-OWNER (376-9637) for assistance.

Chapter 2: Setting Up the DR PRO-21SP Battery Lawn Mower

It may be helpful to familiarize yourself with the controls and features of your DR PRO-21SP Battery Lawn Mower as shown in **Figure 2** before beginning these procedures. If you have any questions at all, please feel free to contact us at www.DRpower.com.

DR PRO-21SP Battery Lawn Mower Controls and Features

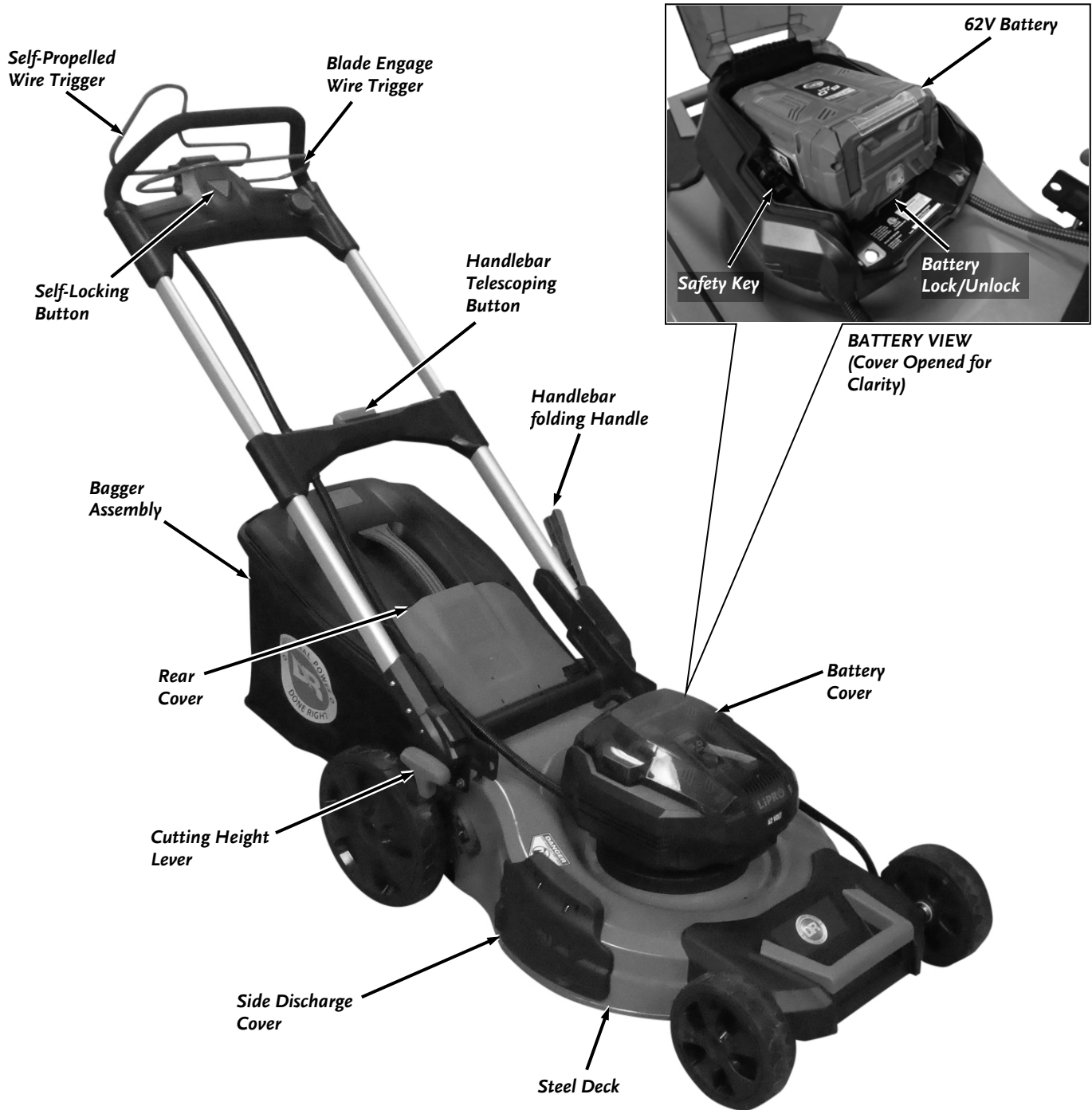
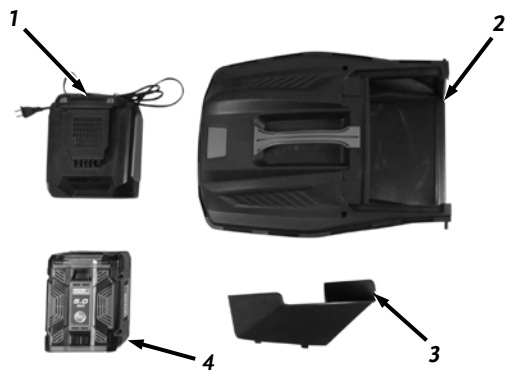

Figure 2

Specifications

Model Number	CE77021XEN
Self-Propel	Yes, adjustable speed
Run Time	45 minutes w/ 5 Ah battery
Motor Power	1250 W brushless motor
Peak Voltage (V)	62.7
Battery	41422 (5 Ah) battery Included
Charger	41424 (5 Ah) charger included
Cutting Width	510mm (21")
Cutting Height	30 - 90 mm (1.2" -3.5"); 7 positions; single point adjustment
Mulching	Yes, Mulching Plug included
Bagging	60L (16 gal) grass catcher included
Discharge	Side discharge guard included
Deck	Stamped steel
Wheel Size	Front: 180mm (7"); Rear: 250mm (10")
Handlebar	Telescoping adjustable handlebar for storage
Wheel Material	PVC and rubber
Dimensions	61 Long X 21.5 Wide (Side Discharge Chute removed) X 44.5 High
Weight	35 kg



Parts Supplied in Shipping Box:

<u>Item #</u>	<u>Description</u>	<u>Qty</u>
1*	Charger, 5 Ah	1
2	Grass Catcher Assembly	1
3	Side Discharge Chute	1
4*	Battery Pack, 5 Ah	1

* Shipped separately

Compare the contents of the Shipping Box with the “Parts Supplied” list above. If you have any questions please contact us at www.DRpower.com or call 1-800-DR-OWNER (376-9637) for assistance.

Figure 3

Charge the Battery Pack before your first use

The DR PRO-21SP Battery Lawn Mower uses a sealed, Lithium-Ion Battery Pack. You MUST charge the Battery Pack for at least 90 minutes before you use the Mower for the first time. If you do not charge it before using the Mower, the

NOTICE

- Make sure the Charger Power Supply is plugged into a normal household voltage, 120volts, 60Hz, AC only.
- You should operate the Battery Charger in a dry place with temperatures between 50°F (10°C) and +100°F (+37.8°C). Operating above +100 °F can cause Battery Pack leakage, rust, or degradation of the Battery Pack performance.

Battery Pack's charging capacity may decrease.

1. Connect the charger to a 120VAC outlet. When the Battery is not installed (no load condition): The Red LED will be lit.
2. Insert the Battery into the Charger (**Figure 4**). Under normal charging the Green LED will Blink.
3. When the Battery is fully charged, the Green LED will remain light, indicating that charging is complete.
4. Unplug the Charger from the Outlet and remove the Battery.

Note: There are more detailed instructions for charging and maintaining the Battery/Charger in Chapter 4

Positioning the Handlebar Assembly

1. Press the Handlebar Folding Handle against the Handlebar (**Figure 5**).
2. As you hold the Folding Handle, rotate the Handlebar up and toward the back, release the Folding Handle, and continue back until it Locks in place.
3. Push in the Handlebar Telescoping Button and pull the Handlebar out until it is fully extended and locks in place (**Figure 6**).

Installing the Battery

1. Open the Battery Cover and insert the Battery into the Mower (**Figure 7**). Ensure the Battery is pushed in completely so the Latch locks it in place.
2. Ensure that the Start Key Tool is inserted into the Key Slot.



Figure 4

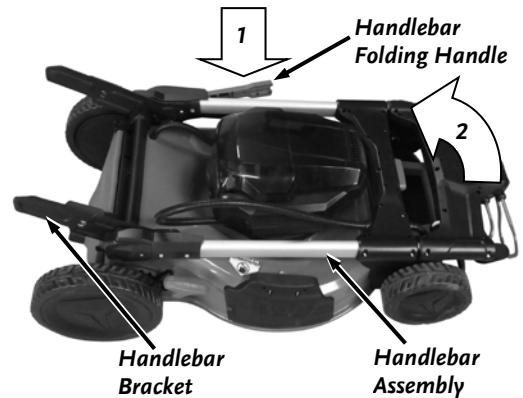

Figure 5

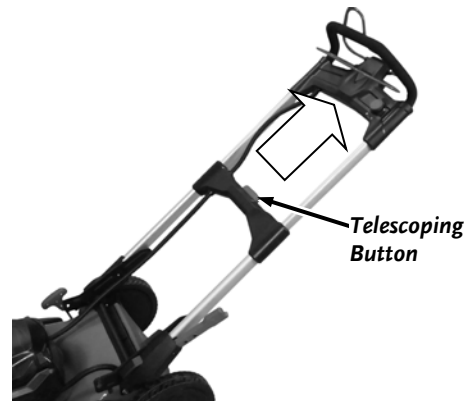

Figure 6

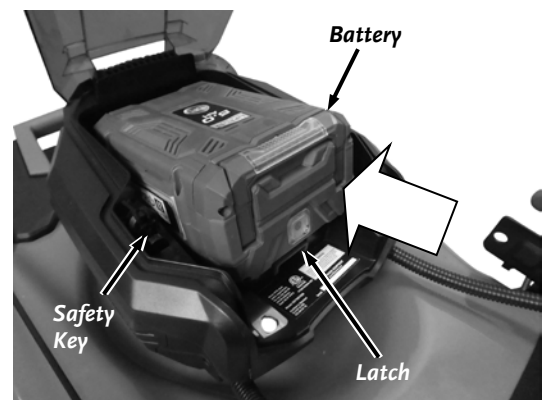

Figure 7

Chapter 3: Operating the DR PRO-21SP Battery Lawn Mower

It may be helpful to better familiarize yourself with the features of your Mower by reviewing **Figure 2** in Chapter 2 before beginning the steps outlined in this chapter.

! WARNING

Read and understand all warnings listed in “Chapter 2 General Safety Rules” before operating this Mower.

Your Mower is set up initially to Mulch. If you would like to use the side discharge or bagging features, go to the “Installing the Side Discharge Chute” or “Installing the Bagger Assembly” section for details.

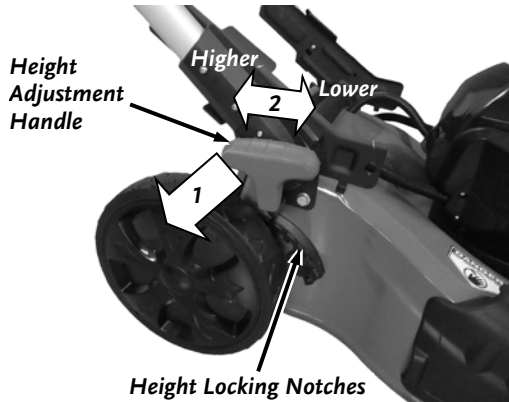

Figure 8

Adjusting the Cutting Height

Use the Height Adjustment Handle to set all four Wheels to the same cutting height as desired (**Figure 8**). Pull Lever outward, move Lever to desired position, and release Lever to lock in notch.

! WARNING

Adjusting the cutting height may bring you into contact with the mowing blade, causing serious injury.

- Stop the Motor and remove the Safety Key.
- Do not put your fingers under the housing when adjusting the cutting height.

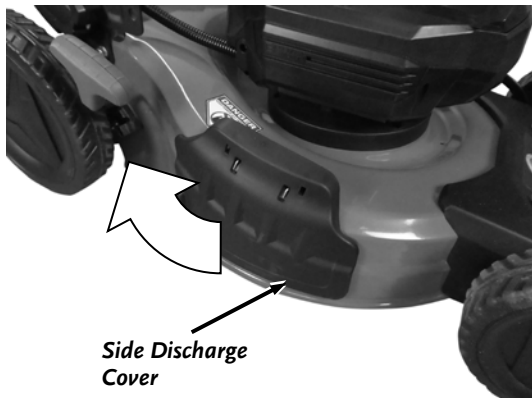

Figure 9

Notch Position	Cutting Height
1st: Fully towards rear of mower	1.2 inch (3.0 cm)
2nd:	1.6 inch (4.1 cm)
3rd:	2.0 inch (5.1 cm)
4th:	2.3 inch (5.8 cm)
5th:	2.7 inch (6.9 cm)
6th:	3.1 inch (7.9 cm)
7th: Fully towards front of mower	3.5 inch (8.9 cm)

Side Discharge Setup

The Side Discharge Chute can be installed to direct clippings out the right side when the Bagger is not installed.

1. Lift the Side Discharge Cover to access the Hinge area (**Figure 9**).
2. Place the Tabs of the Side Discharge Chute under the Hinge Pin (**Figure 10**).
3. Lower the Side Discharge Cover onto the Side Discharge Chute.
4. Ensure that the Mulching Plug is installed when using the Side Discharge Cover. See “Mulching Setup” on the next page.

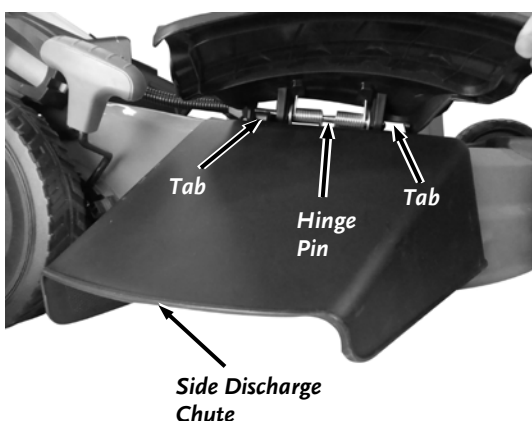

Figure 10

Bagger Setup

The Bagger can be installed to capture clippings for dumping at a designated location. The Mulcher Plug and Side Discharge Chute will need to be removed to direct clippings into the Bagger.

1. Hold the Rear Cover in the upright position (**Figure 10**).

Note: If you are installing the Bagger Assembly prior to operation, remove the Mulching plug shipped in the rear of the machine (**Figure 11**).

2. Place the Rods of the Bagger Assembly onto the Mower Brackets on both sides (**Figure 12**).
3. Lower the Rear Cover onto the Bagger Assembly. Make sure the Cover aligns correctly and fits fully into the grooves of the Bagger Assembly.

Mulching Setup

Setting up the Mower for Mulching allows the material to remain under the Deck longer so it can be chopped into smaller pieces. This will allow the material to return to the lawn and decompose faster.

1. Open the Rear Cover and insert the Mulching Plug (**Figure 13**).
2. Remove the Side Discharge Chute to allow the Side Discharge Cover to close (**Figure 14**).

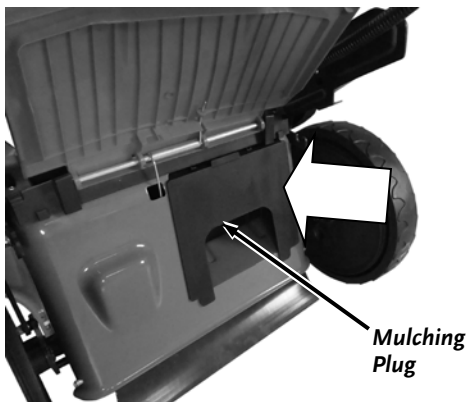

Figure 13

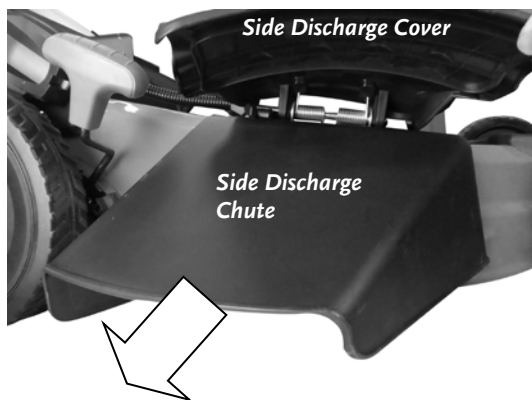

Figure 14

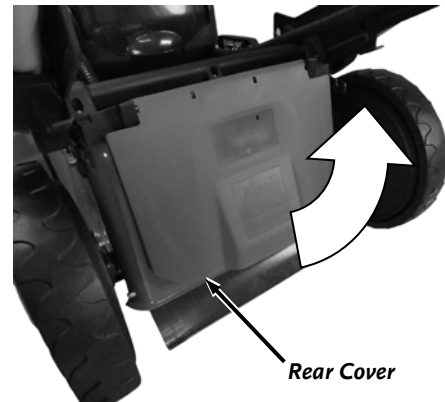

Figure 10

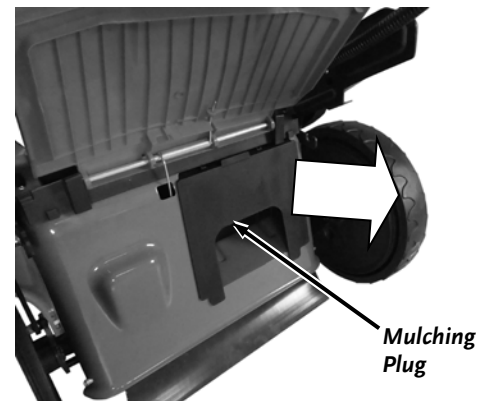

Figure 11

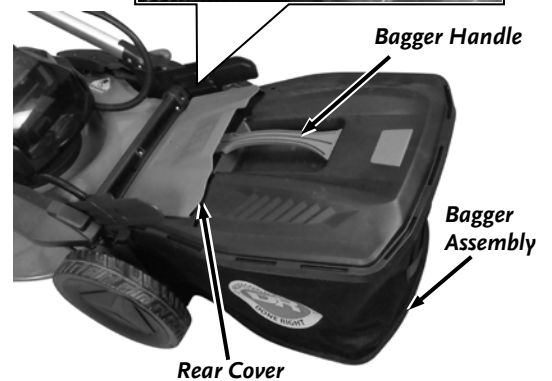
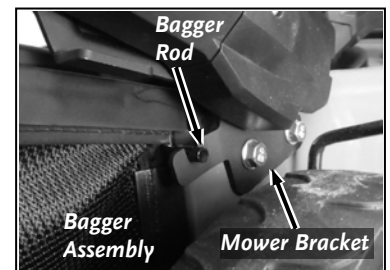

Figure 12

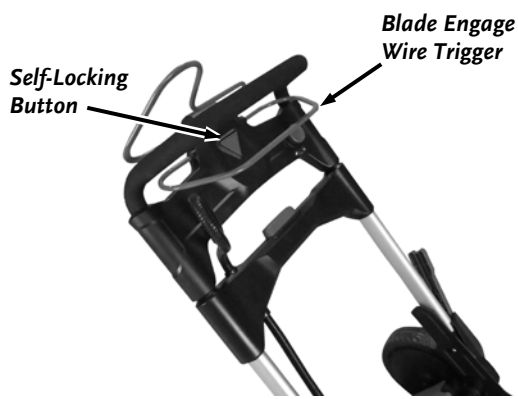

Figure 15

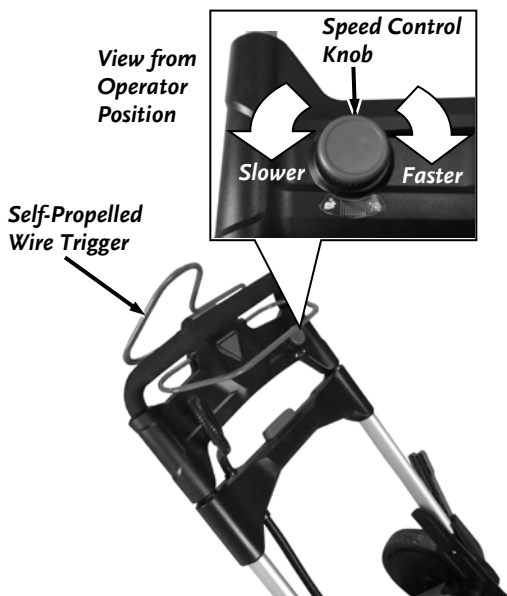

Figure 16

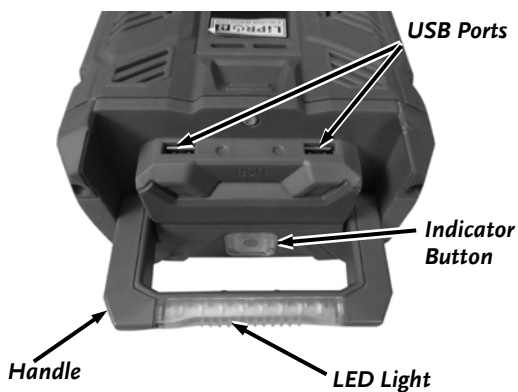

Figure 17

Starting the Blade

! DANGER

Always be aware that the blade is cutting (spinning) while Motor is running. The blade is sharp; contacting the blade can result in serious personal injury.

1. Hold the Self-Locking Button down with one hand as you pull the Blade Engage Wire Trigger to the Handlebar with the other hand (**Figure 15**).
2. Release the Self-Locking Button while still holding the Blade Engage Wire Trigger to the Handlebar to keep the Blade spinning.

Stopping the Blade

1. Release the Blade Engage Wire Trigger to stop the Motor/Blade (**Figure 15**).

Self-Propelled Forward Travel

TO TRAVEL FORWARD

1. Set the Speed Control Knob to the desired setting (**Figure 16**).
2. Push the Self-Propelled Wire Trigger to the Handlebar and the Mower will move forward.

TO STOP TRAVEL FORWARD

1. Release the Self-Propelled Wire Trigger to stop the Mower.

Additional features

USB Charge Ports

The Battery can be used to charge/operate phones or other electronic devices that use a USB cord.

1. Remove the Battery from the Mower.
2. Flip the Handle to the open position (**Figure 17**).
3. Plug the device into one of the USB Ports of the Battery.

LED Light

The Battery flip Handle LED Light is a convenient tool that can be used as a portable light source.

1. Remove the Battery from the Mower.
2. Flip the Handle to the open position (**Figure 17**).
3. Press and hold the Indicator Button until the light turns on.
4. When finished, press and hold the Indicator Button until the light turns off.

Operating Tips

- Clear the area of sticks, stones, wire, branches, and other debris that the Blade could hit.
- Avoid striking solid objects with the Blade. Never deliberately mow over any object.
- If the Mower strikes an object or starts to vibrate, **immediately stop the Motor, remove the Safety Key**, and examine the Mower for damage.
- For best performance, install a new Blade before the cutting season begins.
- Replace the Blade when necessary with a DR Power Equipment replacement Blade.

Cutting Grass

WARNING

Wet grass or leaves can cause serious injury if you slip and contact the Blade. Mow only in dry conditions.

- Do not cut more than a third of the grass blade at a time.
- When cutting grass over 6 inches (15 cm) tall, mow at the highest cutting height setting and walk slower; then mow again at a lower setting for the best lawn appearance. If the grass is too long, the mower may plug and cause the Motor to stop.
- Mow only dry grass or leaves. Wet grass and leaves tend to clump on the yard and can cause the mower to plug or the Motor to stop.
- Alternate the mowing direction. This helps disperse the clippings over the lawn for even fertilization.
- If the finished lawn appearance is unsatisfactory, try one or more of the following:
 - Replace the blade or have it sharpened.
 - Walk at a slower pace while mowing.
 - Raise the cutting height on your mower.
 - Cut the grass more frequently.
 - Overlap cutting swaths instead of cutting a full swath with each pass.

Slope Operation

WARNING

Slopes are a major factor related to slip and fall accidents, which can result in severe injury. Operation on all slopes requires extra caution. If you feel uneasy on a slope, do not mow it.

- Mow across the face of slopes; never up and down. Exercise extreme caution when changing direction on slopes.
 - Watch for holes, ruts, bumps, rocks, or other hidden objects. Uneven terrain could cause a slip and fall accident. Tall grass can hide obstacles.
 - Do not mow on wet grass or excessively steep slopes. Poor footing could cause a slip and fall accident.
 - Do not mow near drop-offs, ditches, or embankments. You could lose your footing or balance.
-

Vertical Storage

The Mower Handlebar can be folded down in a compact position so the machine can be stored vertically. The mower will take up less space stored in this manner. Remove the Battery before storing the Mower. Refer to “Chapter 2: Setting Up the DR PRO-21SP Battery Lawn Mower” section for information on operating the Handlebar telescoping Button and Folding handle.

Chapter 4: Maintaining the DR PRO-21SP Battery Lawn Mower

Regular maintenance is the way to ensure the best performance and long life of your machine. Please refer to this manual for maintenance procedures.

! WARNING

Before performing any maintenance procedure or inspection on the Mower, release the Blade Engage Wire Trigger and then remove the Safety Key.

Regular Maintenance Checklist

PROCEDURE	BEFORE EACH USE
Check Battery Power*	▲
Check General Equipment Condition	▲
Check Blade for Sharpness	▲
Remove grass clippings and dirt from under the housing	▲

Replacing the Blade

Tools and Supplies Needed:

- 27mm Wrench
- Block of Wood
- Gloves

! WARNING

The blade is sharp; contacting the blade can result in serious personal injury. Wear gloves when servicing the blade.

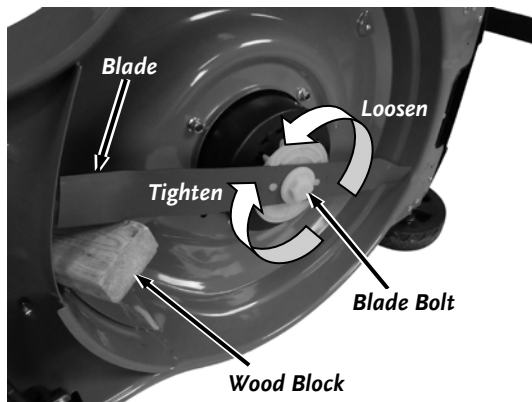

Figure 18

1. Remove the Battery and tip the Mower onto its side to access the Blade under the Deck.
2. Use a block of wood to hold the blade steady (**Figure 18**).
3. Remove the Blade Bolt using a 27mm Wrench.

Note: The Blade will only go onto the location Pins one way. Make sure that the Blade is full onto the Pins before tightening the Blade Bolt.

4. Position the new Blade with its holes aligned with the pins and secure with the Blade Bolt using a 27mm Wrench.

Checking Battery Charge

Check the charge percentage of your 62V Battery by pushing the Indicator Button on the front of the Battery (**Figure 19**). The number of Green LED indicators will tell you the % of power left in the battery. 1 LED = 25%, 2 LEDs = 50%, 3 LEDs = 75% and 4 LEDs = 100%.

If you press the Indicator Button and only the fourth LED flashes, the Battery needs charging.

Charger indicator Lights (Figure 20)

Red LED Lit, green LED is not lit; The Charger is plugged in but the Battery is not installed (no load condition).

Green LED blinks, red LED is not lit; Battery is charging normally.

The green LED is on, red LED is not lit; Battery is fully charged.

Green LED is not lit, red LED blinks; There is a fault with the Battery or Charger. Remove the Battery from the Charger and wait about 30 minutes, then reinsert the Battery into the Charger.

If the Battery does not hold its charge for very long under normal conditions or it simply won't hold a charge, then replace it. You can purchase a replacement Battery directly from us at www.DRpower.com.



Figure 19

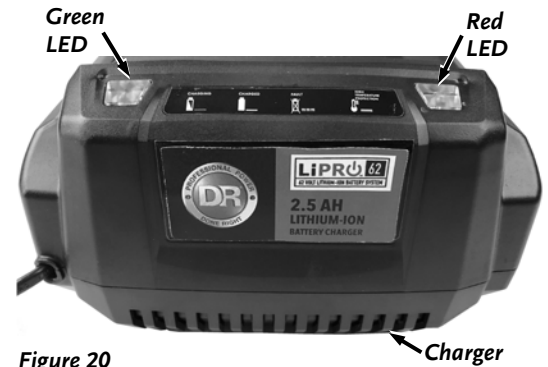

Figure 20

Additional Battery Pack and Charger information

The Battery Pack should not leak, regardless of the position in which it is stored. Read “Handling the Battery Safely” in Chapter 1 for additional information. The Battery Pack is completely maintenance free. You never need to add water. With all rechargeable Batteries, after years of use, they will eventually need replacement

! CAUTION

Use only the DR® 62V Charger with DR® 62V Battery Packs. Do not try to use the DR® 62V Charger with Battery Packs from other manufacturers or other DR® products.

NOTICE

- Make sure the Charger Power Supply is plugged into a normal household voltage, 120volts, 60Hz, AC only.
 - You should operate the Battery Charger in a dry place with temperatures between 50°F (10°C) and +100°F (+37.8°C). Operating above +100 °F can cause Battery Pack leakage, rust, or degradation of the Battery Pack performance.
 - Disconnect Charger Power Supply from the household voltage power when not in use to prevent damage to the Charger during a power surge.
 - Periodically inspect the Cord on the Charger unit for damage. If damage occurs, do not use the Charger until you have replaced or repaired the Cord. Do not abuse the Cord. Never carry the Charger by the Cord. Always pull the plug and not the Cord when disconnecting the Power Supply from the electrical outlet (wall outlet) and from the Charger. When using an extension Cord with your Charger, use a heavy-duty extension Cord of a type 'suitable for outdoor use' (although you should never charge the Battery Pack in the open outdoors).
 - The Battery Pack requires 2-3 charging and discharging cycles before reaching full charge ability.
 - A Battery Pack may last much longer if you charge it as soon as it starts to lose power and not let it completely discharge. Recharge the Battery Pack as soon as the trimming power of your DR Hedge Trimmer is no longer effective. This would be a good time to have a spare Battery Pack ready to go. Recharge the Battery Pack for up to 75 minutes or until fully charged and remove it from the Charger.
 - A good time to consider purchasing a replacement Battery Pack is when it loses its power quickly.
-

Recycling a Used Battery

NOTICE

Please dispose of used batteries responsibly, according to your local hazardous materials regulations. Never throw away used batteries in your household trash.

Please dispose of your used Batteries responsibly by recycling them. Call your local Solid Waste Management District or your local waste handler to locate the collection site nearest you. Some collection sites recycle Batteries year-round; others collect them periodically.

You can also visit the Website of Earth 911 for more information (www.earth911.com). Once there, click Recycle Guide at the top of the page, then click the Municipal HHW link under Hazardous Household Waste, and enter your zip code. The site lists recycling centers located near you.

For a fee, you can recycle your Batteries with the International Metals Reclamation Company. Visit them at www.inmetco.com and click Services, then click Battery Recycling; or contact them at: INMETCO, One INMETCO Drive, Ellwood City, PA 16117, (724) 758-5515; fax (724) 758-2845.

To learn more about hazardous waste recycling, visit the Website for Battery Council International (www.batterycouncil.org) or for the Environmental Protection Agency (www.epa.gov)

Chapter 5: Troubleshooting

Most problems are easy to fix. Consult the Troubleshooting Table below for common problems and their solutions. If you continue to experience problems, contact us at www.DRpower.com or call toll-free 1-800-DR-OWNER (376-9637) for support.

WARNING

Before performing any maintenance procedure or inspection on the Mower, release the Blade Engage Wire Trigger to shut down the Motor and then remove the Battery and Safety Key.

Troubleshooting Table

SYMPTOM	POSSIBLE CAUSE
<i>The Motor fails to start with the Safety Key and Battery installed, and the Control Bar depressed.</i>	<ul style="list-style-type: none"> ⇒ Check to make sure that you properly inserted the Safety Key. ⇒ Check that you installed the Battery correctly and that the Battery is fully charged. All four LEDs of the Battery Test Button should light up when pressed if it is fully charged. If not, replace with a fully charged Battery or recharge the Battery. ⇒ Make sure you follow the correct starting sequence of pushing the Safety Lock Button in first and then pulling the Wire Trigger to the Handlebar. ⇒ Possibly the Blade is obstructed. Remove the Safety Key and Battery, turn the Mower over, and check the Blade to make sure the Blade spins freely and is unobstructed.
<i>The Battery Pack will not charge.</i>	<ul style="list-style-type: none"> ⇒ Check to see if the Battery Pack is all the way into the Charger. Insert the Battery Pack until the Green LED Light illuminates. ⇒ The Charger Power Cord is not plugged into a working outlet. Check the outlet with a lamp or other appliance. ⇒ Check to see if the outlet that you are using for the Charger Power Supply is controlled from a wall switch. ⇒ The surrounding air temperature is too hot or too cold. Move Charger and Battery Pack to a location where the surrounding air temperature is between 50°F (10°C) and +100°F (+37.8°C).
<i>The Mower runs slow.</i>	<ul style="list-style-type: none"> ⇒ The Battery Pack was probably not at full charge prior to cutting. Charge the Battery Pack, if necessary. ⇒ Check the Blade for sharpness or damage. Sharpen or replace as needed. ⇒ The Grass is too tall for the mower. Set the cut height higher if the grass is of reasonable height for the Battery Mower or mow first with a DR Brush Mower.
<i>The Motor doesn't have much power when you use the Mower for the first time.</i>	<ul style="list-style-type: none"> ⇒ The Motor doesn't have much power when you use the Mower for the first time.
<i>The Battery loses its charge quickly.</i>	<ul style="list-style-type: none"> ⇒ The Battery Pack was probably not at full charge prior to trimming. Charge the Battery Pack, if necessary. ⇒ The Battery Pack may be getting old. After some time, you will need to replace the Battery Pack.
<i>The Mower stops while mowing (for reasons other than releasing the Blade Engage Wire Trigger).</i>	<ul style="list-style-type: none"> ⇒ The Battery Power is depleted. Recharge the Battery or install a fully charged Battery. ⇒ The Blade, Mower Deck, or Side Discharge Chute probably clogged with debris. Remove the Safety Key and Battery, turn the Mower over, and clean if necessary. ⇒ If the Mower bogs down or stalls in heavy grass, raise the cutting height, walk more slowly, or cut a narrower swath. If the grass is wet, let it dry before mowing.
<i>Excessive vibration or noise</i>	<ul style="list-style-type: none"> ⇒ The Blade may be loose. Remove the Safety Key and the Battery; turn the Mower over and check that the Blade is securely attached. ⇒ The Blade may be unbalanced, bent, or damaged. Remove the Safety Key and Battery, turn the Mower over, remove the Blade, and check its condition. Replace with a new Blade if necessary.

Chapter 6: Parts Lists and Schematic Diagrams

Parts List – PRO-21SP Battery Lawn Mower

Note: Part numbers listed are available through DR Power Equipment.

Ref#	Part#	Description	Ref#	Part#	Description
1	42046	Blade Bolt	43	42264	Bolt
2	42131	Blade	44	42265	Deep Groove Ball Bearing
3	42048	Fan	45	42168	Cross Recessed Pan Head Triple Combination Screw
4	42226	S1-62V Power System Set	46	42169	Bearing Base
5	41424	Battery Pack	47	42268	Rear Wheel Axle
6	42073	7" Wheel Cover	48	42269	L Gear
7	42051	Non-Metal Insert Flange Nut	49	42270	Variable Speed Self-Propelled Transmission Set
8	42074	7" Wheel	50	42171	Gear Torsional Spring Base
9	42053	Wave Washer	51	42172	Pull Rod Torsional Spring
10	42054	Square Neck Head Bolt	52	42173	Gear Set
11	42139	Front Wheel Axle Lower Support	53	42174	Pull Rod Spiale
12	42058	Weighting Spring	54	42097	E-Shaped Elastic Ring-Shield
13	42142	Front Wheel Axle Top Support	55	42078	Right Height Adjustment Handle
14	42140	Front Wheel Axle	56	42079	Left Height Adjustment Handle
15	42059	Hexagon Flange Locknut	57	41800	Hexalobular Socket Pan Head Tapping Screws
16	42237	21" Steel Deck	58	42279	Self-Propelled Transmission Pressing Plate
17	42062	Hexalobular Socket Pan Head Tapping Screws	59	42280	Telescopic Play Button
18	42146	Front Face	60	42281	Spring
19	42147	Lifting Handle	61	42282	Switch Box
20	42129	Flat Washer	62	42283	Microswitch
21	42148	Connecting Rod	63	42120	Cable Pressing Plate
22	41790	Hexagon Locknut	64	42285	Switch Box Cover
23	42066	Hexagon Socket Button-Headed Screw	65	42286	Cross Recessed Countersunk Head Tapping Screws
24	42158	Gear Plate	66	42287	Cord Sets
25	42159	Grass Guide Plate	67	42288	Corrugated Hose
26	42160	Mulching Plug	68	42289	Cap Nut
27	42248	Trailing Shield	69	42290	Right Top Decorative Cover
28	42249	Pressing Plate	70	42291	Right Lower Decorative Cover
29	42071	Cross Recessed Pan Head Screw	71	42292	Spring
30	42072	Hexagon Flange Locknut	72	42293	Right Pulling Board
31	42151	Side Discharge Chute	73	42294	Elastic Round Pin
32	42152	Side Discharge Cover	74	42295	Right Pop-Up Pin
33	42153	Side Discharge Cover Bolt	75	42296	Pull Board Spiale
34	42154	Side Discharge Torsional Spring	76	42297	E-Shaped Elastic Ring-Shield
35	42155	Side Discharge Bracket	77	42298	Foldable Hollow Bolt
36	42156	Square Neck Head Bolt	78	42299	Right Connecting Board
37	42258	10" Wheel Cover	79	42089	Hexagon Flange Head Bolt
38	42259	10" Wheel	80	42301	Foldable Handlebar Right Bracket
39	42260	10" Wheel Inner Cover			
40	42167	Flat Washer			
41	42262	Circlip for Shaft			
42	42263	R Gear			

Parts List – PRO-21SP Battery Lawn Mower (continued)

Note: Part numbers listed are available through DR Power Equipment.

Ref#	Part#	Description	Ref#	Part#	Description
81	42302	Trigger Gasket	121	42342	Switch
82	42303	Hexagon Locknut	122	42343	Lower Operation Panel
83	42304	Foldable Handlebar Left Bracket	123	42344	Spring Pressing Plate
84	42305	Left Connecting Board	124	42345	Top Operation Panel
85	42101	Hexalobular Socket Pan Head Tapping Screws	125	42346	Spring
86	42307	Pulling Board Lining	126	42347	Self-Locking Button
87	42308	Left Pulling Board	127	42348	Flat Washer
88	42309	Left Decorative Cover	128	42349	Hexagon Thin Nut
89	42310	Cross Recessed Countersunk Head Screw	129	42350	Speed Governing Board
90	42311	Foldable Seat	130	42351	Cross Recessed Pan Head Tapping Screw
91	42312	Spring	131	42352	Speed Control Knob
92	42313	Left Pop-Up Pin	132	42353	Speed Control Knob Soft Cover
93	42314	Pull Rod for Folding Function	133	42354	S.S. Wire Trigger
94	42315	Handle for Folding Function	134	42355	Switch Trigger Bracket
95	42316	Zipper for Folding Function	135	42356	Top Handrail
96	42317	Dust Excluder Cover	136	42357	Self-Propelled Trigger Bracket
97	42188	Rear Cover	137	42358	Spring
98	42095	Cap Nut	138	42359	Self-Propelled S.S. Wire Trigger
99	42190	Dust Excluder	139	42360	Rubber Hose
100	42093	Square Neck Head Bolt	140	42361	Trigger Block
101	42193	Rear Cover Bolt	141	42362	Flat Washer
102	42098	Rear Cover Torsional Spring	142	42363	Self-Propelled Cord Sets
103	42324	50L Grass Catcher	143	42364	Discharge Plate
104	42103	Gasket	144	42365	Hexagon Locknut
105	42197	Grass Catcher Bracket	145	42366	Hexagon Lobular Socket Countersunk Head Screw
106	42198	50L Grass Catcher Cover			
107	42199	Grass Catcher Handle			
108	42200	Wind Door Cover	Not Shown		
109	42330	Lower Handlebar	41422		5Ah Charger
110	42331	Sleeve			
111	42332	Positioning Sleeve			
112	42333	Top Handlebar			
113	42334	Connecting Sleeve			
114	42335	Handlebar Lower Bracket			
115	42336	Sliding Sleeve			
116	42337	Position Limit Lock Shaft			
117	42338	Trigger Slider			
118	42339	Cross Recessed Pan Head Screw			
119	42340	Handlebar Top Bracket			
120	42341	Telescopic Press Button			

Schematic – PRO-21SP Battery Lawn Mower

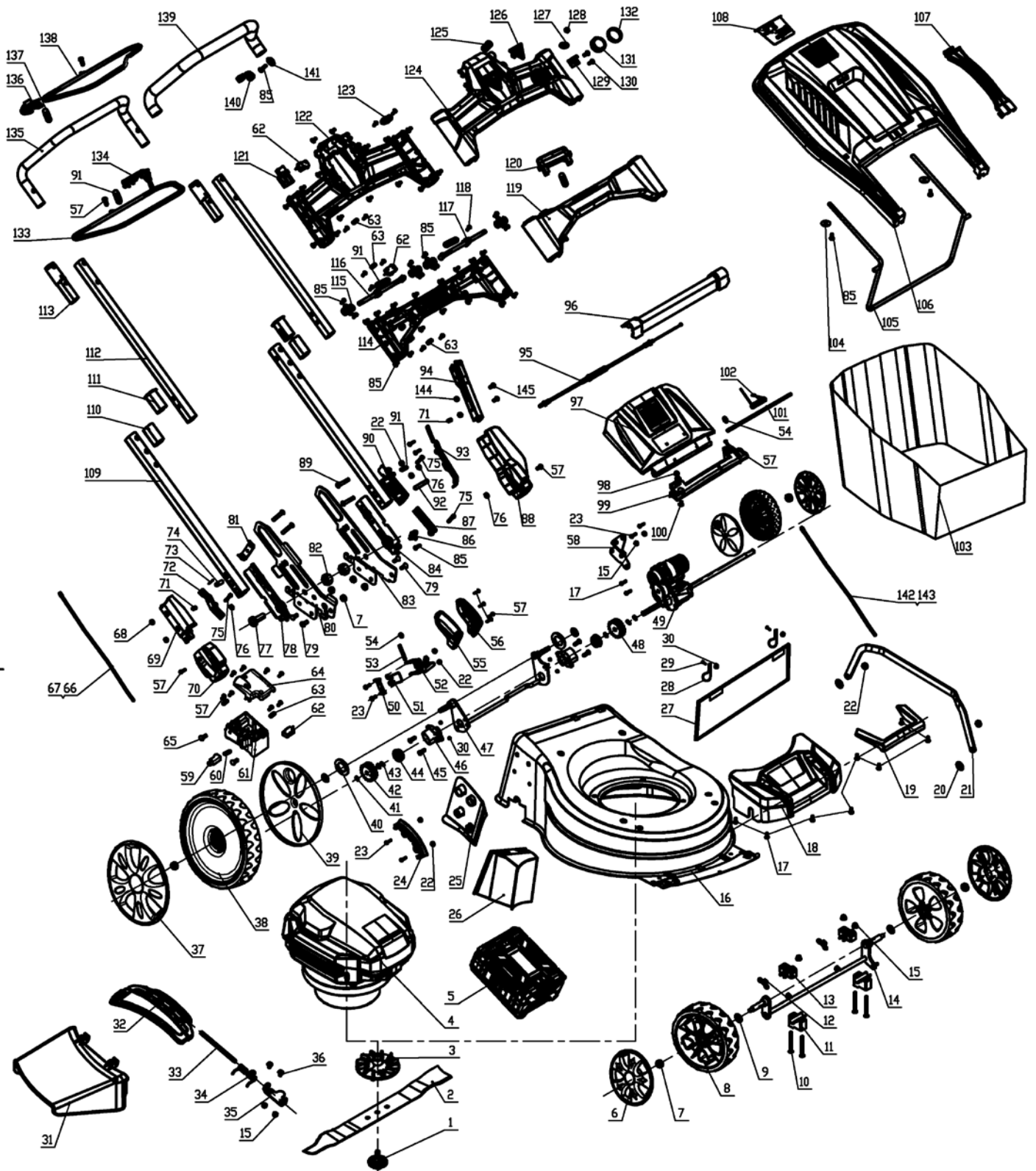

DR® PRO-21SP BATTERY LAWN



2-Year Limited Warranty

Terms and Conditions

The DR® PRO-21SP BATTERY LAWN MOWER is warranted for two (2) years (except for the Battery, which carries a one (1) year warranty) against defects in materials or workmanship when put to ordinary and normal personal residential use.

For the purposes of all the above warranties, “ordinary and normal personal residential use” refers to non-commercial residential use and further excludes misuse, accidents or damage due to inadequate maintenance.

DR Power Equipment certifies that the DR® PRO-21SP BATTERY LAWN MOWER is fit for ordinary purposes for which a product of this type is used. DR Power Equipment however, limits the implied warranties of merchantability and fitness in duration to a period of two (2) years in personal residential household use.

The 2-Year Limited Warranty on the DR® PRO-21SP BATTERY LAWN MOWER starts on the date the machine ships from our factory. The 2-Year Limited Warranty is applicable only to the original owner.

The warranty holder is responsible for the performance of all the required maintenance as defined by the manufacturer's owner's manuals.

The warranty holder is responsible for replacement of normally wearing parts such as the Battery Pack and Blade.

During the warranty period, the warranty holder is responsible for the machine transportation charges, if required. During the warranty period, warranty parts will be shipped by standard method at no charge to the warranty holder. Expedited shipping of warranty parts is the responsibility of the warranty holder.

SOME STATES DO NOT ALLOW LIMITATIONS ON THE LENGTH OF IMPLIED WARRANTIES, SO THE ABOVE LIMITATIONS MAY NOT APPLY TO YOU.

DR Power Equipment shall not be liable under any circumstances for any **incidental or consequential damages or expenses** of any kind, including, but not limited to, cost of equipment rentals, loss of profit, or cost of hiring services to perform tasks normally performed by the DR® PRO-21SP BATTERY LAWN MOWER.

SOME STATES DO NOT ALLOW THE EXCLUSION OR LIMITATION OF INCIDENTAL OR CONSEQUENTIAL DAMAGES, SO THE ABOVE LIMITATIONS MAY NOT APPLY TO YOU.

THIS WARRANTY GIVES YOU SPECIFIC LEGAL RIGHTS, AND YOU ALSO HAVE OTHER RIGHTS, WHICH VARY FROM STATE TO STATE.

Notes:

Daily Checklist for the DR PRO-21SP Battery Lawn Mower

WARNING

Before performing any maintenance procedure or inspection on the Mower, release the Blade Engage Wire Trigger to shut down the Motor and then remove the Battery and Safety Key.

To help maintain your DR PRO-21SP Battery Lawn Mower for optimum performance, we recommend you follow this checklist each time you use your Mower.

- [] BATTERY: Make sure the Battery has a full charge.
- [] BLADE: Check that the Blade for sharpness and damage.
- [] MOWER: Check the general condition of the Mower, e.g.; nuts, bolts, welds, etc.
- [] CLEANING: Check if there is any buildup of grass on the Mower and under the deck. Clean as needed.

End of Season and Storage

WARNING

Before performing any maintenance procedure or inspection on the Mower, release the Blade Engage Wire Trigger to shut down the Motor and then remove the Battery and Safety Key.

- When mower is to be stored, remove all grass, dirt, grease, leaves, etc.
- At the end of your mowing season, remove the Battery from the machine and follow the charging procedures as outlined in Chapter 4. Once charging is complete, remove the Charger from the Battery and from your standard 110-Volt wall outlet. Store the Battery in a DRY environment with temperatures between +5°F (-15°C) and +104°F (+40°C) unplugged from the Charger and separate from the Mower. Every one to two months thereafter and just prior to the first mowing of the season, you should completely charge the Battery again for optimal performance and life.
- Store the Mower in a dry environment. Water will damage the Mower and Battery.
- Do not store the Battery close to a source of heat, sparks, or open flame.
- Always keep the Safety Key in a safe place away from children, separate of the Mower.
- Store the Battery away from children and animals.
- Store your mower indoors and cover it with a suitable protective cover to give protection from dust and dirt. Do not use plastic. Plastic cannot breathe which allows condensation to form and will cause some mower parts to rust.



75 MEIGS ROAD, P.O. BOX 25, VERGENNES, VERMONT 05491