

DR[®] 5 -TON, ELECTRIC WOOD SPLITTER



SAFETY & OPERATING INSTRUCTIONS



! WARNING!

READ AND UNDERSTAND THIS MANUAL AND ALL INSTRUCTIONS BEFORE OPERATING THIS WOOD SPLITTER.

THANK YOU!

and congratulations on your purchase of a new DR 5 -TON ELECTRIC WOOD SPLITTER!

We have done our utmost to ensure that your DR 5 -TON ELECTRIC WOOD SPLITTER will be one of the most trouble-free and satisfying pieces of equipment you have ever owned. Please let us know of any questions you may have. We want to answer them as quickly as possible. When you do call, please have your serial number or order number handy. **For technical assistance, please call Toll-Free 1-800-DR-OWNER (376-9637) and one of our Technical Support Representatives will be happy to help you.** We also hope to hear from you on how much you like your new helper.

In addition, please tell your friends about your new DR 5 -TON ELECTRIC WOOD SPLITTER! Having DR Owners spread the word about our products and our way of doing business is the best advertising we can have, and the best way to help us provide even better service in the years to come.

Thanks once again!



for all of us at
Country Home Products, Inc.

SALES MANAGER

COPYRIGHT

©2006 Country Home Products, Inc. All rights reserved.



DR® Power Equipment
A division of Country Home Products®
127 Meigs Road
Vergennes, VT 05491

Toll-free phone: 1-800-DR-OWNER (376-9637)
Fax: 1-802-877-1213
Web site: www.dr-owner.com

Table of Contents

CHAPTER 1.....	1
INTRODUCING THE DR 5 -TON ELECTRIC WOOD SPLITTER.....	1
Conventions used in this manual	1
Specifications for the DR 5 -TON ELECTRIC WOOD SPLITTER	2
CHAPTER 2.....	3
GENERAL SAFETY RULES.....	3
Labels	3
Protecting Yourself and Those Around You	4
Operating the Wood Splitter Safely.....	4
Safety for Children	5
Safety with Electric-Powered Machines	6
Hydraulic Safety	7
Additional Information and Potential Changes.....	8
CHAPTER 3.....	9
UNPACKING AND ASSEMBLING YOUR DR 5 -TON ELECTRIC WOOD SPLITTER...	9
DR 5 -TON ELECTRIC WOOD SPLITTER Controls and Features	10
Unpacking and Assembling the DR 5 -TON ELECTRIC WOOD SPLITTER	11
CHAPTER 4.....	13
OPERATING YOUR DR 5 -TON ELECTRIC WOOD SPLITTER	13
Before Starting the Electric Motor.....	13
Splitting Safety	15
Operating the DR 5 -TON ELECTRIC WOOD SPLITTER.....	16
How to Free a Jammed Log from the Wedge.....	17
CHAPTER 5.....	19
MAINTAINING THE DR 5 -TON ELECTRIC WOOD SPLITTER.....	19
Regular Maintenance Checklist before each use.....	19
Before each season.....	19
Adjusting the Hydraulic Fluid Level	20
Sharpening the Wedge	20
Electrical Connections	21
CHAPTER 6.....	23
TROUBLESHOOTING.....	23
Troubleshooting Table.....	23
CHAPTER 7.....	25
PARTS LISTS, SCHEMATIC DIAGRAMS AND WARRANTY.....	25
Parts List - DR 5 -TON ELECTRIC WOOD SPLITTER	25
Schematic - DR 5 -TON ELECTRIC WOOD SPLITTER.....	27
Optional Accessories.....	28
Notes.....	28
Warranty.....	29

INTRODUCING THE DR 5 -TON ELECTRIC WOOD SPLITTER

This manual will help you set up and safely operate your new DR 5 -TON ELECTRIC WOOD SPLITTER. Careful adherence to the safety and operating instructions in this manual will ensure many years of productive use.

Please let us know of any questions you may have. We want to answer them as quickly as possible. When you do call, please have your serial number and/or order number handy. **For technical assistance, please call Toll-Free 1-800-DR-OWNER (376-9637) and one of our Technical Support Representatives will be happy to help you.**

Conventions used in this manual

! WARNING!

THIS INDICATES A HAZARDOUS SITUATION, WHICH, IF NOT AVOIDED, COULD RESULT IN DEATH OR SERIOUS INJURY.

! CAUTION!

THIS INDICATES A HAZARDOUS SITUATION, WHICH, IF NOT AVOIDED, COULD RESULT IN MINOR OR MODERATE INJURY.

! NOTICE!

THIS INFORMATION IS IMPORTANT IN THE PROPER USE OF YOUR MACHINE. FAILURE TO FOLLOW THIS INSTRUCTION COULD RESULT IN DAMAGE TO YOUR MACHINE OR PROPERTY.

Tip: This is a helpful hint to guide you in getting the most out of your DR 5 -TON ELECTRIC WOOD SPLITTER.

Tools Needed: This indicates you will need a specific tool to perform a maintenance function on your DR 5 -TON ELECTRIC WOOD SPLITTER.

NOTE: *This information may be helpful to you.*

If you are ever unsure about an action you are about to take, don't do it, contact Country Home Products' toll-free support at 1-800-DR-OWNER (376-9637) for help or information.

Specifications for the DR 5 -TON ELECTRIC WOOD SPLITTER

MAXIMUM RAM FORCE	10,000 lbf
MAXIMUM LOG LENGTH	20"
MAXIMUM LOG DIAMETER	12"
MAXIMUM RAM TRAVEL (TYPICAL)	19"
CLOSED GAP	2"
RAM CYLINDER DIAMETER	2.2"
RAM CYCLE TIME (TYPICAL)	22 seconds
VALVE TYPE	1-Speed Valve
RAM RETURN MECHANISM	Hydraulic
RAM FACE	4" x 4"
HYDRAULIC FLUID RESERVOIR	4L
HYDRAULIC FLUID for 40°F to 105°F	AW32
HYDRAULIC FLUID for -20°F to 105°F	Dexron Auto Transmission Fluid
WEDGE HEIGHT	5"
MOTOR RPM	3450
MOTOR HORSEPOWER (Output)	1.8 HP - Continuous 2.7 HP Peak
MOTOR VOLTAGE	120 V/ 60hz
MINIMUM OPERATING VOLTAGE	105 V
POWER CORD	6' UL Certified
RECOMMENDED EXTENSION CORD	12 Gauge--Up to 33' Length
WHEEL SIZE	5.75" (dia.) x 2" width
WEIGHT OF UNIT	120lbs
UNIT SIZE L x W x H	38.5" x 14.5" x 19.5"
BOX DIMENSIONS L x W x H (no pallet)	41.5" x 12.5" x 21"
SHIPPING DIMENSIONS ON PALLET L x W x H	41.5" x 13" x 26"
SHIPPING WEIGHT ON PALLET	142lbs

CHAPTER 2

GENERAL SAFETY RULES







! WARNING!

READ THIS SAFETY AND OPERATING MANUAL BEFORE YOU USE THE DR 5 -TON ELECTRIC WOOD SPLITTER. BECOME FAMILIAR WITH THE SERVICE RECOMMENDATIONS TO ENSURE THE BEST PERFORMANCE FROM YOUR WOOD SPLITTER.

Labels

Your DR 5 -TON ELECTRIC WOOD SPLITTER carries prominent labels as reminders for its proper and safe use. Shown below are copies of all the labels that appear on the equipment. Take a moment to study them and make a note of their location on your DR 5 -TON ELECTRIC WOOD SPLITTER as you assemble and *before* you operate the machine. Replace damaged or missing safety and information labels immediately.

! WARNING! AVOID SERIOUS INJURY OR DEATH

 Read the Safety and Operating Instructions Manual before using.	 Always operate from operator zone, and away from pets and children.	 Never operate near natural gas or flammable liquids.	 Always unplug splitter and read service manual before servicing.	 Use proper protective gear for hands, feet and face.	 Never place your hand near the ram or wedge during operation.	 Never operate splitter on wet, uneven, unstable, or sloping surfaces.
--	--	---	---	--	--	--

#211891

AIR BLEED SCREW OPERATION

- Prior to using your DR® WOOD SPLITTER, open the Air-Bleed Screw by turning it counter-clockwise four turns.
- Leave the valve open in this position while using the splitter.
- Tighten the screw by turning it clockwise and close the valve when you are finished with the splitter.
Note: Do not over tighten the screw. It is not necessary to crank the screw tight.

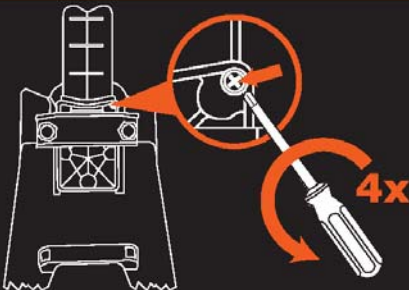

#206861

! WARNING!

OPERATING INSTRUCTIONS

- Read Operator's Manual for complete instructions before operating.
- Work Safely: wear eye protection, gloves and sturdy footwear.
- Check Motor Switch is OFF
- OPEN Bleed Screw
- Connect Power
- Turn Motor Switch ON
- Load log between guide rails against wedge.
- Move Ram Control Lever to advance and split.
- Release Ram Control Lever to retract.
- Turn Motor Switch OFF and DISCONNECT Power and CLOSE Bleed Screw when done splitting or leaving machine unattended.

ALWAYS KEEP HANDS AWAY FROM LOG WHEN SPLITTING

#211901

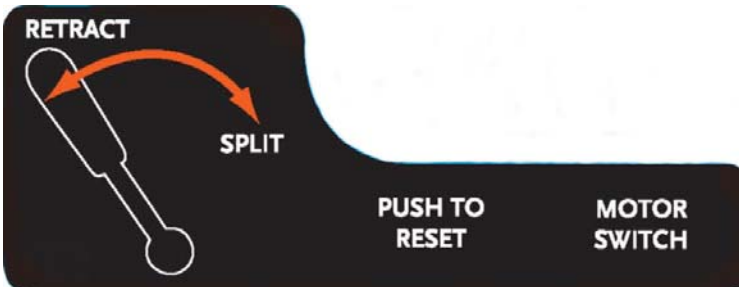

#211911

Protecting Yourself and Those Around You

WARNING!

THIS IS A POWERFUL MACHINE. YOU MUST USE PROPER CLOTHING AND SAFETY GEAR WHEN OPERATING THIS MACHINE TO PREVENT OR MINIMIZE THE RISK OF SEVERE INJURY. THIS MACHINE CAN CUT, AND SEVER PARTS OF YOUR BODY IF THEY BECOME CAUGHT BETWEEN THE RAM, LOG, GUIDING PLATES AND/OR THE SPLITTING WEDGE. ALWAYS TAKE THE FOLLOWING PRECAUTIONS WHEN OPERATING THIS MACHINE:

- ALWAYS WEAR PROTECTIVE GOGGLES OR SAFETY GLASSES WITH SIDE SHIELDS WHILE SPLITTING WOOD TO PROTECT YOUR EYES FROM POSSIBLE THROWN BITS OF WOOD.
 - WEAR SHOES WITH NON-SLIP TREADS WHEN USING YOUR DR 5 -TON ELECTRIC WOOD SPLITTER. IF YOU HAVE SAFETY SHOES, WE RECOMMEND WEARING THEM. DO NOT USE THE MACHINE WHILE BAREFOOT OR WEARING OPEN SANDALS.
 - AVOID WEARING LOOSE CLOTHING OR JEWELRY, WHICH CAN CATCH ON THE WOOD SPLITTER'S MOVING PARTS.
 - WE RECOMMEND WEARING GLOVES WHILE SPLITTING WOOD. BE SURE YOUR GLOVES FIT PROPERLY AND DO NOT HAVE LOOSE CUFFS OR DRAWSTRINGS.
-

Operating the Wood Splitter Safely

WARNING!

THIS IS A POWERFUL MACHINE. YOU MUST OPERATE THE MACHINE SAFELY. UNSAFE OPERATION CAN CREATE A NUMBER OF HAZARDS FOR YOU. ALWAYS TAKE THE FOLLOWING PRECAUTIONS WHEN USING THIS MACHINE:

- NEVER ALLOW PEOPLE WHO ARE UNFAMILIAR WITH THESE INSTRUCTIONS TO USE THE DR 5 -TON ELECTRIC WOOD SPLITTER.
- TO BE SAFE, DO NOT OPERATE THE MACHINE NEAR SMALL CHILDREN OR PETS, AND NEVER ALLOW CHILDREN TO OPERATE THE WOOD SPLITTER. RETRACT THE RAM AND STOP THE MOTOR WHEN ANOTHER PERSON OR PET APPROACHES.
- NEVER TEAM UP WITH ANOTHER PERSON TO OPERATE THE WOOD SPLITTER CONTROLS – THIS IS A ONE PERSON JOB.
- KEEP YOUR HANDS AND FEET AWAY FROM THE SPLITTING AREA WHILE THE RAM IS IN MOTION.
- USE ONLY YOUR HANDS TO OPERATE THE WOOD SPLITTER CONTROLS.
- DO NOT PLACE YOUR HANDS AT PINCH POINTS WHERE THEY CAN CATCH BETWEEN A LOG AND THE WEDGE, LOG GUIDING PLATES OR THE RAM.
- DO NOT PUT ANY PART OF YOURSELF, YOUR CLOTHING, OR YOUR PERSONAL PROTECTIVE EQUIPMENT INTO A CRACK IN A LOG THAT YOU ARE SPLITTING; IT MIGHT CLOSE SUDDENLY WITH GREAT FORCE.
- NEVER SPLIT ANYTHING OTHER THAN LOGS FREE OF NAILS, WIRES, AND BRANCHES. MAXIMUM LOG LENGTH IS 20" WITH A MAXIMUM DIAMETER OF 12" FOR THE DR 5 -TON WOOD SPLITTER.

NOTE: The log diameter does not necessarily indicate the difficulty of the split. A small diameter log can be difficult to split if it has knots or its fiber is very tough, whereas you can split a larger log easily if its fiber is smooth and loose.

! WARNING!

- NEVER OPERATE THE WOOD SPLITTER IN AN AREA OF NATURAL GAS OR FLAMMABLE LIQUIDS.
- NEVER SPLIT WOOD IN WET OR SLIPPERY CONDITIONS.
- ALWAYS OPERATE THE WOOD SPLITTER FROM THE OPERATOR ZONE (*FIGURE 11 ON PAGE 15*). NEVER STAND ON, STRADDLE, OR CLIMB OVER THE WOOD SPLITTER AT ANY TIME.
- DO NOT HANDLE LOGS BY THEIR ENDS WHEN YOU POSITION THEM ON THE WOOD SPLITTER.

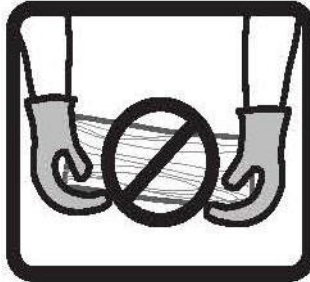

- ALWAYS UNPLUG THE WOOD SPLITTER FROM THE POWER SOURCE BEFORE ADJUSTING OR SERVICING THE MACHINE. IF YOU HAVE TO STOP TO REMOVE ANY DEBRIS FROM THE MACHINE, ALWAYS RETRACT THE RAM AND UNPLUG THE MACHINE.
 - DO NOT MOVE OR REPOSITION THE WOOD SPLITTER WITH ITS MOTOR RUNNING.
 - DO NOT, UNDER ANY CONDITIONS, REMOVE, BEND, CUT, FIT, WELD, OR OTHERWISE ALTER STANDARD PARTS ON THE DR 5 -TON ELECTRIC WOOD SPLITTER. MODIFICATIONS TO YOUR MACHINE COULD CAUSE PERSONAL INJURIES AND WILL VOID YOUR WARRANTY.
 - WHILE USING THE DR 5 -TON ELECTRIC WOOD SPLITTER, DON'T HURRY OR TAKE THINGS FOR GRANTED.
 - DO NOT OPERATE THE MACHINE WHEN UNDER THE INFLUENCE OF ALCOHOL, DRUGS, OR MEDICATION.
 - USE THE MACHINE ONLY IN DAYLIGHT.
-

Safety for Children

! WARNING!

TRAGIC ACCIDENTS CAN OCCUR IF THE OPERATOR IS NOT ALERT TO THE PRESENCE OF CHILDREN. CHILDREN ARE OFTEN ATTRACTED TO THE WOOD SPLITTER AND THE SPLITTING ACTIVITY. NEVER ASSUME THAT CHILDREN WILL REMAIN WHERE YOU LAST SAW THEM.

- KEEP CHILDREN OUT OF THE SPLITTING AREA AND UNDER THE WATCHFUL CARE OF A RESPONSIBLE ADULT.
 - BE ALERT AND TURN THE WOOD SPLITTER OFF IF CHILDREN ENTER THE WORK AREA.
 - NEVER ALLOW CHILDREN TO OPERATE THE DR 5 -TON ELECTRIC WOOD SPLITTER.
-

Safety with Electric-Powered Machines

WARNING!

NEVER OVERLOOK THE HAZARDS OF ELECTRICITY. ALWAYS FOLLOW THESE PRECAUTIONS:

- NEVER OPEN THE SWITCH BOX OR MOTOR COVER. NEVER ATTEMPT ANY ELECTRICAL REPAIRS YOURSELF. IF IN DOUBT, CONSULT A QUALIFIED ELECTRICIAN OR CONTACT COUNTRY HOME PRODUCTS' TOLL-FREE SUPPORT AT **1-800-DR-OWNER (376-9637)** FOR HELP OR INFORMATION.
 - NEVER OPERATE THE WOOD SPLITTER IF THERE IS AN ELECTRICAL HAZARD PRESENT.
 - NEVER OPERATE THE WOOD SPLITTER IN WET CONDITIONS.
 - NEVER OPERATE THE WOOD SPLITTER WITH A DAMAGED ELECTRICAL CORD OR DAMAGED EXTENSION CORD.
 - NEVER PULL ON THE POWER CORD TO MOVE THE MACHINE.
 - ALWAYS GRASP THE POWER CORD PLUG WHEN UNPLUGGING THE CORD FROM THE OUTLET; NEVER PULL THE PLUG OUT BY THE CORD.
 - NEVER OPERATE THE WOOD SPLITTER UNLESS THE POWER CORD IS PLUGGED INTO A PROPERLY GROUNDED OUTLET, WHICH SUPPLIES 110-120V POWER, AND IS PROTECTED BY A 15-AMP CIRCUIT BREAKER.
 - NEVER TAMPER WITH SAFETY DEVICES. CHECK THEIR PROPER OPERATION REGULARLY.
 - IF YOU WILL USE AN EXTENSION CORD, WE RECOMMEND THAT YOU KEEP THE CONNECTION BETWEEN THE POWER CORD AND THE EXTENSION CORD WELL AWAY FROM ANY WATER.
 - NEVER USE AN EXTENSION CORD LONGER THAN 33 FEET OR SMALLER THAN 12 AWG IN DIAMETER, BECAUSE THE CORD WILL PRODUCE A VOLTAGE DROP THAT WILL PREVENT THE MOTOR FROM SUPPLYING FULL POWER AND MAY CAUSE DAMAGE TO THE MOTOR.
 - ALWAYS KEEP THE POWER CORD AND/OR EXTENSION CORD AWAY FROM EXCESSIVE HEAT, OIL, AND SHARP OBJECTS.
-

Tip: Reference page 23 for Troubleshooting Tips.

Hydraulic Safety

WARNING!

ESCAPING PRESSURIZED FLUID FROM HYDRAULIC SYSTEM LEAKS CAN HAVE ENOUGH FORCE TO PENETRATE SKIN AND CAUSE SERIOUS INJURY OR DEATH. HYDRAULIC FLUID CAN REMAIN PRESSURIZED WHILE THE MOTOR IS OFF DUE TO THE RETURN SPRING FORCE ON THE RAM. ALWAYS FOLLOW THESE PRECAUTIONS:

- ALWAYS RELEASE RESIDUAL ENERGY FROM PRESSURIZED HYDRAULIC FLUID AND ALLOW THE FLUID TO COOL BEFORE DOING ANY MAINTENANCE OR REPAIR WORK ON THE WOOD SPLITTER.
 - PLEASE FOLLOW THESE STEPS TO DEPRESSURIZE THE SYSTEM AND RELEASE RESIDUAL HYDRAULIC ENERGY BEFORE STARTING ANY REPAIRS.
 - UNPLUG THE WOOD SPLITTER FROM THE POWER SOURCE.
 - MOVE THE OPERATING HANDLE DOWN AND UP FROM ONE LIMIT OF TRAVEL TO THE OTHER AT LEAST FOUR TIMES. HOLD THE HANDLE FOR THREE SECONDS AT EACH LIMIT OF TRAVEL. THE RAM SHOULD NOT MOVE DURING THE 4TH CYCLE AND SHOULD REMAIN FULLY RETRACTED.
 - CALL 1-800-DR-OWNER (376-9637), OR A QUALIFIED HYDRAULIC MECHANIC, FOR ASSISTANCE TO REPLACE WORN COMPONENTS.
 - NEVER USE YOUR HAND OR ANY PART OF YOUR BODY TO CHECK FOR HYDRAULIC SYSTEM LEAKS WHILE THE SYSTEM IS PRESSURIZED.
 - NEVER REMOVE THE FILL/DIPSTICK CAP FROM THE HYDRAULIC FLUID PORT WHILE THE MOTOR IS RUNNING OR WHILE THE TANK IS STILL WARM AFTER THE MOTOR IS OFF. HOT PRESSURIZED FLUID CAN CAUSE SERIOUS INJURY, SO WAIT FOR THE HYDRAULIC TANK TO COOL BEFORE REMOVING CAP.
 - THE WOOD SPLITTER MUST BE ON A LEVEL SURFACE.
 - PERIODICALLY CHECK FOR HYDRAULIC FLUID LEAKS BY PLACING A SHEET OF CARDBOARD UNDER THE WOOD SPLITTER WHILE THE SYSTEM IS RUNNING.
 - GET PROFESSIONAL MEDICAL HELP AT ONCE IF HYDRAULIC OIL PENETRATES ANYONE'S SKIN.
 - NEVER ADJUST THE HYDRAULIC SYSTEM.
-

Tip: Reference page 23 for Troubleshooting Tips.

! CAUTION!

THE WOOD SPLITTER MUST BE OPERATED SAFELY TO PREVENT OR MINIMIZE THE RISK OF MINOR OR MODERATE INJURY. UNSAFE OPERATION CAN CREATE A NUMBER OF HAZARDS FOR YOU. ALWAYS TAKE THE FOLLOWING PRECAUTIONS WHEN OPERATING THIS WOOD SPLITTER:

- KEEP IN MIND THAT THE OPERATOR OR USER IS RESPONSIBLE FOR ACCIDENTS OR HAZARDS OCCURRING TO OTHER PEOPLE, THEIR PROPERTY, AND THEMSELVES.
 - WEAR LONG PANTS WHILE SPLITTING WOOD.
 - ALWAYS CUT THE ENDS OF THE LOG YOU ARE SPLITTING AS SQUARELY AS POSSIBLE.
 - NEVER SPLIT MORE THAN ONE LOG AT A TIME UNLESS THE RAM HAS BEEN FULLY EXTENDED AND A SECOND LOG IS NEEDED TO COMPLETE THE SPLIT OF THE FIRST LOG.
 - NEVER PUT ANYTHING BETWEEN THE LOG GUIDING PLATES AND THE SIDE OF A LOG; LOGS SPREAD AS THEY ARE FORCED AGAINST THE WEDGE.
 - NEVER OPERATE THE RAM IN A STALLED POSITION FOR MORE THAN 5 SECONDS. THE HYDRAULIC FLUID MAY OVERHEAT AND DAMAGE THE MACHINE. IF THE WOOD BEING SPLIT IS EXCESSIVELY HARD, STOP THE MACHINE, ROTATE THE LOG 90° AND TRY AGAIN. IF YOU STILL CANNOT SPLIT THE LOG, REJECT THE LOG AS IT EXCEEDS THE CAPACITY OF THE MACHINE.
 - NEVER LEAVE THE WOOD SPLITTER UNATTENDED. IF YOU LEAVE THE AREA, UNPLUG THE POWER SOURCE.
 - CLEAN UP AS YOU WORK; ACCUMULATED SPLIT WOOD AND WOOD CHIPS CAN CREATE A HAZARDOUS WORK ENVIRONMENT.
 - ALWAYS CHECK THE ALIGNMENT OF MOVING PARTS AND FOR DAMAGED OR WORN PARTS.
 - KEEP ALL NUTS AND BOLTS TIGHT AND KEEP THE EQUIPMENT AND ATTACHMENTS IN GOOD OPERATING CONDITION.
 - ALWAYS CHECK THE POWER CABLE FOR DAMAGE PRIOR TO EVERY USE AND THAT IT IS FULLY PROTECTED FROM DAMAGE FROM THE EQUIPMENT OR MATERIALS WHILE OPERATING THE MACHINE.
 - SEE MANUFACTURER'S INSTRUCTIONS FOR PROPER OPERATION AND INSTALLATION OF ACCESSORIES. ONLY USE ACCESSORIES APPROVED BY COUNTRY HOME PRODUCTS, INC.
 - NO LIST OF WARNINGS AND CAUTIONS CAN BE ALL-INCLUSIVE. IF SITUATIONS OCCUR THAT ARE NOT COVERED BY THIS MANUAL, THE OPERATOR MUST APPLY COMMON SENSE AND OPERATE THIS WOOD SPLITTER IN A SAFE MANNER. CALL 1-800-DR-OWNER (376-9637) FOR ASSISTANCE.
-

Additional Information and Potential Changes

Country Home Products, Inc. reserves the right to discontinue, change, and improve its products at any time without notice or obligation to the purchaser. The descriptions and specifications contained in this manual were in effect at printing. Equipment described within this manual may be optional. Some illustrations may not be applicable to your machine.

UNPACKING AND ASSEMBLING YOUR DR 5 -TON ELECTRIC WOOD SPLITTER

This chapter outlines a few simple steps you will need to follow to unpack and assemble your new machine before you use it. Familiarize yourself with the controls and features on your new wood splitter by reviewing *Figure 1* on page 10 before beginning the steps outlined in this chapter. **If you have any questions at all, please feel free to contact our Technical Support Representatives at our toll free number: 1-800-DR-OWNER (376-9637).**

DR 5-TON ELECTRIC WOOD SPLITTER Controls and Features

NOTE: The model shown in Figure 1 may look slightly different from your machine.

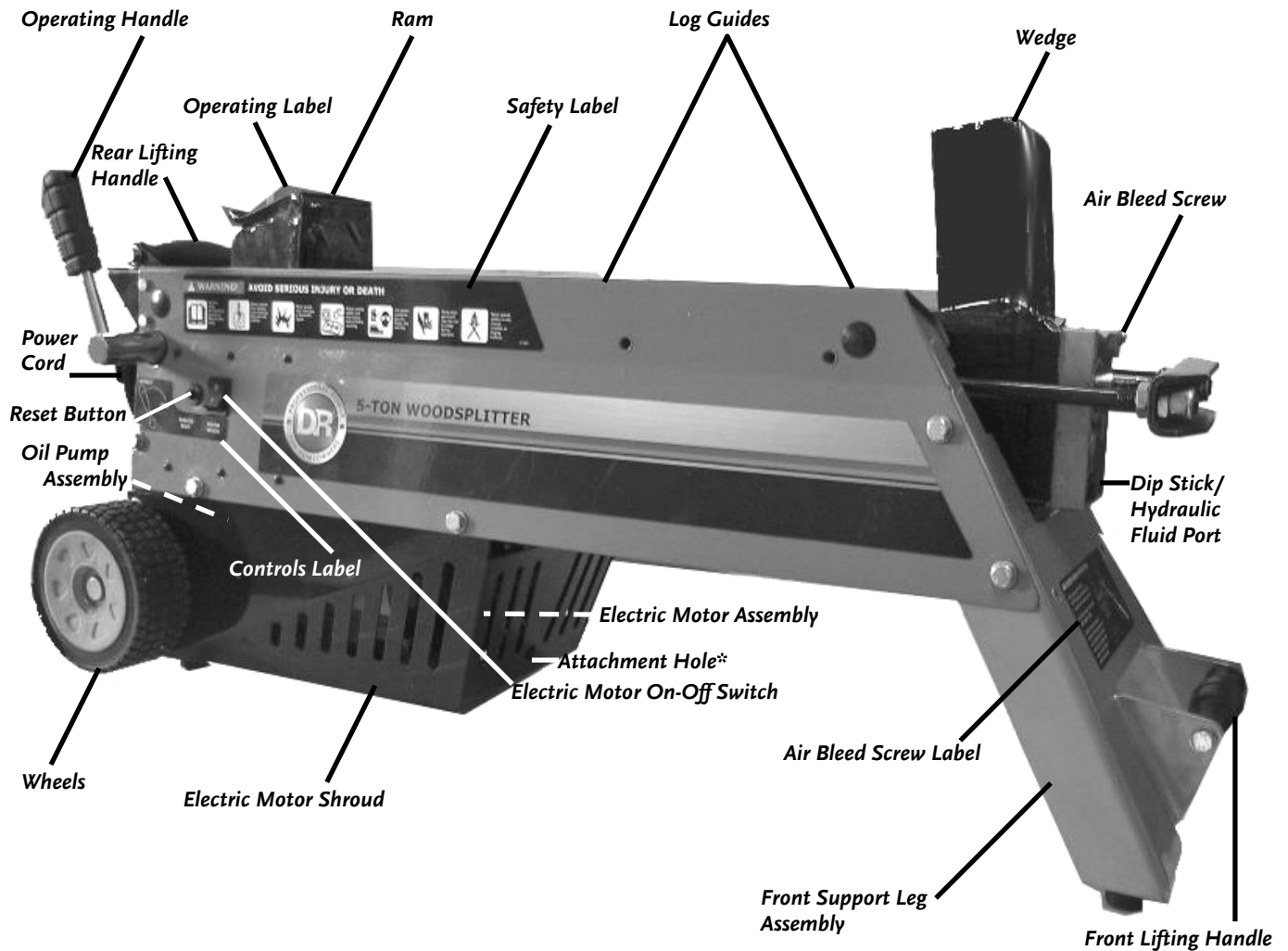

*The hole provided is for the Safety J-Hook supplied with the Optional Stand. See page 28.

Figure 1

Unpacking and Assembling the DR 5 -TON ELECTRIC WOOD SPLITTER

NOTE: Read this Safety & Operating Instructions Manual before using your new DR 5 -TON ELECTRIC WOOD SPLITTER. The wood splitter shipped from the factory fully assembled with the exception of the Wheels and the Operation Handle. The following instructions will detail how to unpack and assemble the machine.

Tools and Parts Supplied:

- 6mm Hex Wrench
- 10 - 12mm Wrench
- 13 - 16mm Wrench
- Operating Handle w/
Retaining Bolt and Washer
- (2) 6mm Bolts
- Extra Hydraulic Seal
- (2) Wheels



Additional Tool Required:

- Knife

CAUTION!

STABILIZE THE SHIPPING CONTAINER ON A FLAT SURFACE BEFORE ATTEMPTING TO UNPACK AND ASSEMBLE THE MACHINE.

1. With the help of another person (the machine weighs 120 pounds), carefully roll the shipping carton over onto its top.
2. Carefully cut the tape along the bottom seam of the shipping carton with a knife, open the carton, and remove the Wheel from the packing; setting it aside (**Figure 2**).
3. Now, carefully roll the shipping carton back onto its bottom (**Figure 3**) and lift the shipping carton off your new DR 5 -TON ELECTRIC WOOD SPLITTER (**Figure 4**). The machine should now be resting on the Front Support Legs and the Rear Support.
4. Remove the second Wheel from the packing (setting it aside) and any remaining packing materials from the machine. Do not discard your packaging material until you are fully satisfied with your new DR 5 -TON ELECTRIC WOOD SPLITTER.



Figure 2

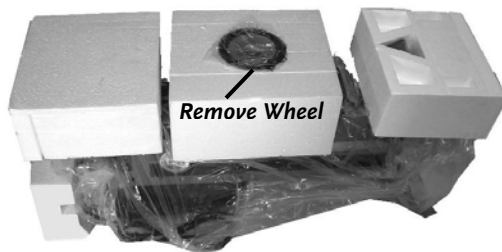

Figure 4

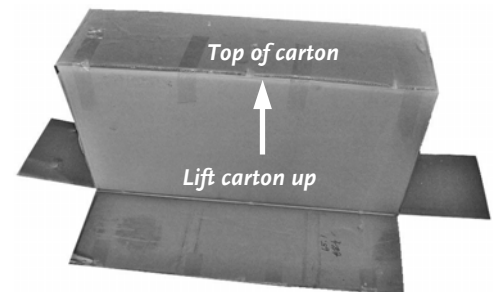

Figure 3

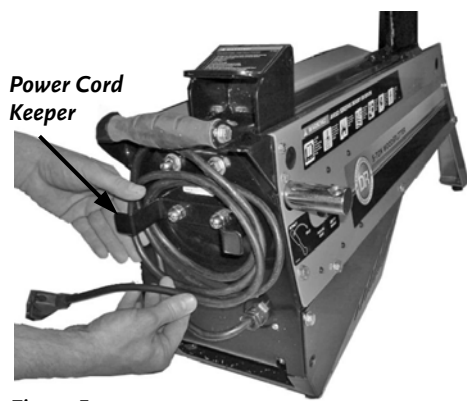

Figure 5

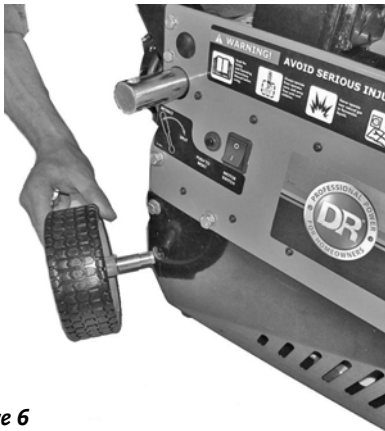

Figure 6

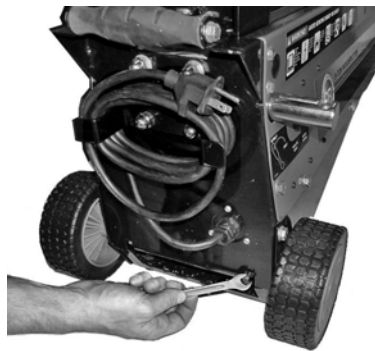

Figure 7

5. Wrap the Power Cord around the Power Cord Keeper (*Figure 5*).
6. Insert a Wheel Axle all the way into the hole at the rear of the frame (*Figure 6*) and install a 6mm Bolt (*Figure 7*). Tighten the Bolt with the 10mm Wrench (*Figure 7*).
7. Repeat step 5 for the other rear Wheel on the opposite side of the machine.
8. Remove the Operating Handle Retaining Screw and Washer from the end of the Handle Shaft.
9. Insert the Operating Handle Shaft into the recessed hole on top of the cylindrical shaft protruding from the right rear side of the machine. Thread the Retaining Bolt with Washer up through the hole in the bottom of the cylindrical shaft and into the Operating Handle shaft (*Figure 8*).
10. While holding the Operating Handle Grip tight with the flat surface of the Operating Handle Grip facing forward, tighten the Retaining Bolt using the 6mm Hex Wrench (*Figure 8*).

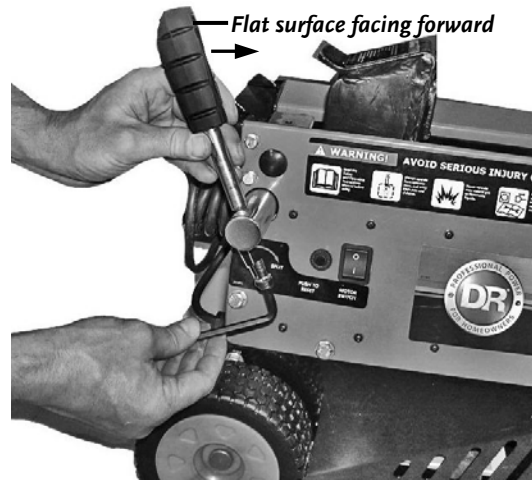

Figure 8

! NOTICE!

BEFORE ATTEMPTING TO OPERATE YOUR NEW DR 5 -TON ELECTRIC WOOD SPLITTER, READ THE SECTION TITLED "BEFORE STARTING THE ELECTRIC MOTOR" ON PAGE 13 IN THE SAFETY & OPERATING INSTRUCTIONS MANUAL.

If you have questions, please call one of our Technical Support Representatives **TOLL-FREE: 1-800-DR-OWNER (376-9637)**.

OPERATING YOUR DR 5 -TON ELECTRIC WOOD SPLITTER

This chapter covers the procedures for operating your new DR 5 -TON ELECTRIC WOOD SPLITTER and discusses basic operation features. You may find it helpful to review the Controls and Features on page 10.

Before Starting the Electric Motor

Tools Needed:

- 6mm Hex Wrench
- #3 Phillips Screwdriver

1. Inspect the area in which you will be working.

- Place the wood splitter only on a firm, level, supported surface 2 to 3 feet above the ground.
- NEVER operate the wood splitter on the ground as there is risk of injury and would not be comfortable for the operator while in use.
- The site must be free of slippery surfaces and potentially hazardous obstacles. Also, make sure there won't be people or animals within a six-foot radius around the wood splitter.

2. Plan your work before you start.

- Have the logs that you are splitting positioned where you can easily reach them. Remember, the maximum log length is 20" and the maximum diameter is 12" for this wood splitter.
- Split only dry, seasoned logs as they will split more easily than green logs. Green logs may stick on the wedge and jam the wood splitter.
- Have a site located where the split wood can be stacked or loaded onto a truck or nearby carrier.

! NOTICE!

- ALWAYS MAKE CERTAIN THAT THE MACHINE IS ON A FIRM LEVEL SURFACE.
- IT IS IMPORTANT THAT THE AIR BLEED SCREW IS OPEN WHEN YOU USE THE MACHINE. YOU WILL NEED A #3 PHILLIPS SCREWDRIVER TO MAKE THIS ADJUSTMENT (*FIGURE 9*).
- USE CARE, DO NOT OVER TIGHTEN AND STRIP THE AIR BLEED SCREW THREADS.

3. Prior to using the wood splitter, open the Air Bleed Screw by turning it counter-clockwise four (4) times. **Leave the Air Bleed Screw open in this position while using the machine.** We recommend closing the Air Bleed Screw after each use, but you can leave the Air Bleed Screw open when you are finished, unless you are going to transport the machine, at which time you should close the Air Bleed Screw being careful not to over tighten and strip the screw.

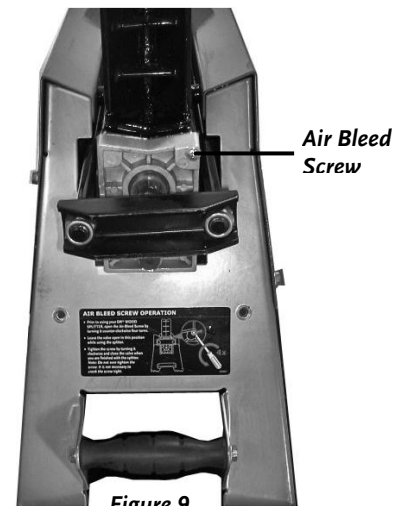

Figure 9

4. Connect the electric cord from the wood splitter to a standard electrical, 110-120VAC, grounded power source fused at 15 AMPS. If using an extension cord, it must be 12AWG and less than 33 feet long with a rating of 15 AMPS. Route the cord from the wood splitter to the power source in such a way that safeguards against damaging the cord during the wood splitting session. Be sure to avoid wet conditions.
 5. Turn ON the Motor, then cycle the Ram several times using the Operating Handle. After cycling, if the Ram does not travel to within 5" of the wedge, proceed to steps 6 through 8.
 6. Check the hydraulic fluid level by tipping the machine up on the Wheels and Rear Handle. Clean the area around the Hydraulic Fluid Fill/Drain Port (**Figure 10**) and then, using the 6mm Hex Wrench provided, unscrew the Dipstick located in the Hydraulic Fluid Fill/Drain Port.
 7. Clean the Dipstick and check the level (do not screw the Dipstick down when checking); it should be between the two marks on the Dipstick. If the fluid is too high, simply pour out a little at a time into a suitable container by tilting the wood splitter. If the fluid is too low, add an AW32 hydraulic fluid, a little at a time until the level falls between the two marks on the dipstick.
 8. Clean the Dipstick and the O-ring seal thoroughly and reinstall being careful not to damage the threads of the aluminum Hydraulic Fluid Cylinder End Cover.
- Tip:** In cold weather, cycle the Ram to warm-up the hydraulic fluid. This will provide full power from your DR 5 -TON ELECTRIC WOOD SPLITTER.



Figure 10

Splitting Safety

The DR 5 -TON ELECTRIC WOOD SPLITTER has a Ram with 5 tons of force.

! WARNING!

- **ALWAYS BE SURE TO STAND INSIDE THE OPERATOR ZONE WHEN OPERATING THE WOOD SPLITTER (FIGURE 11). THIS IS THE AREA DIRECTLY BEHIND YOUR DR 5 -TON ELECTRIC WOOD SPLITTER. NEVER OPERATE THE WOOD SPLITTER FROM ANYWHERE ELSE.**
- **HANDLE LOGS ONLY FROM THE SIDES, NEVER BY THE ENDS.**
- **FOR BEST SPLITTING RESULTS, PLACE LOG FLAT ON THE BEAM BETWEEN THE LOG GUIDES WITH BUTT END AGAINST THE LEADING EDGE OF THE WEDGE (FIGURE 11).**
- **NEVER ATTEMPT TO SPLIT A LOG AT AN ANGLE AND BE SURE THE WEDGE AND RAM WILL CONTACT THE LOG SQUARELY ON THE ENDS.**
- **BE VERY CAREFUL TO KEEP ARMS AND FINGERS AWAY FROM THE WEDGE, RAM, AND SPLITTING AREA.**
- **KEEP HANDS AND FINGERS CLEAR AT ALL TIMES. MANY WOOD SPLITTING ACCIDENTS HAPPEN ON THE RETURN PORTION OF THE STROKE.**
- **DO NOT PUT ANY PART OF YOUR BODY WITHIN THE SPLITTING AREA. USE A STICK IF YOU NEED TO REMOVE DEBRIS FROM THE SPLITTING AREA (FIGURE 11).**

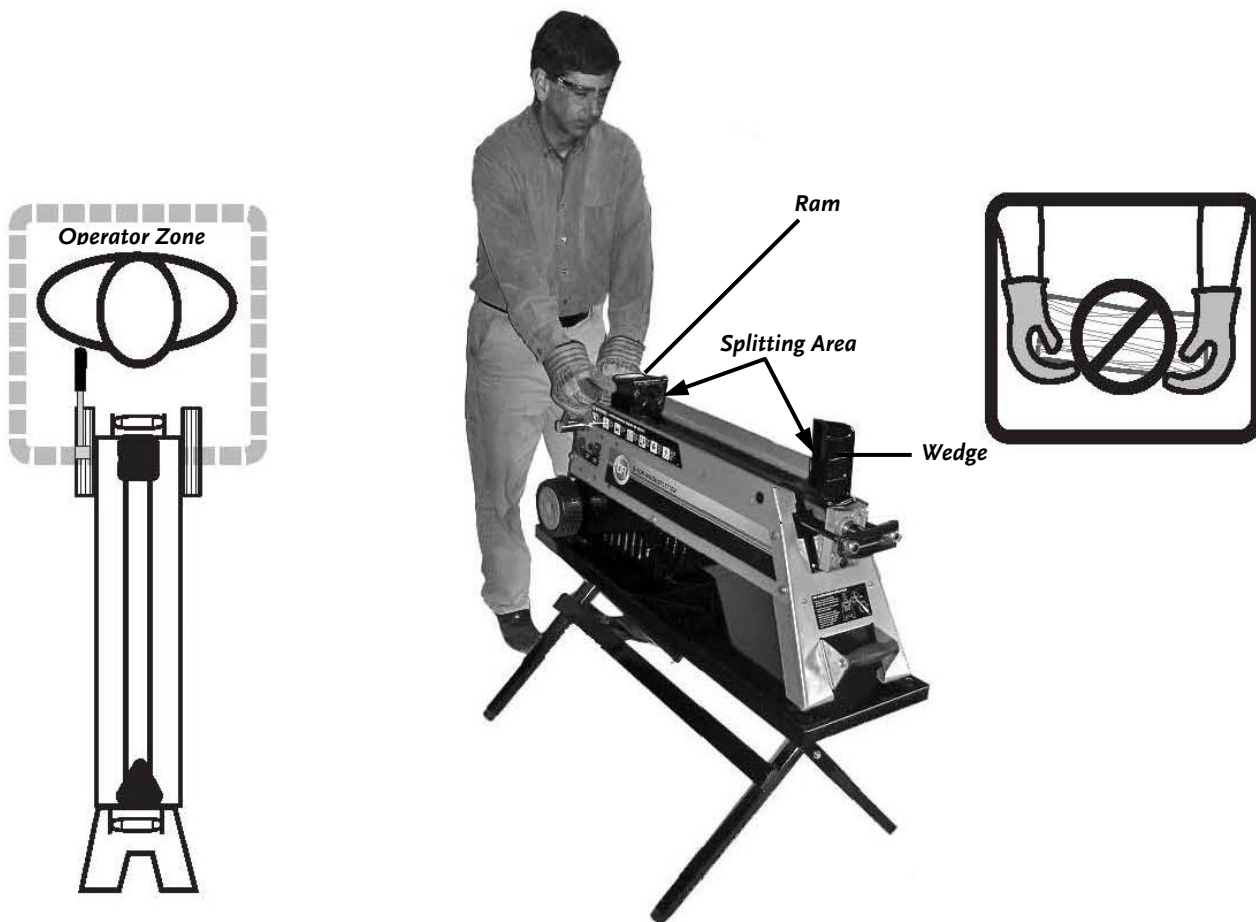

Operator Zone
Figure 11

CALL TOLL FREE 1-800-DR-OWNER

Operating the DR 5 -TON ELECTRIC WOOD SPLITTER

NOTE 1: The hydraulic control is a single handle valve called the Operating Handle. With the Electric Motor Control Switch is ON, the ram travels forward when you push the Operating Handle forward. The cylinder will retract when you release the Operating Handle.

NOTE 2: Before starting the splitting operation, the log Ram should be cycled 3 to 4 times back and forth (with the Air Bleed Screw open). This will remove any air that may have mixed into the hydraulic fluid from shipping and handling. See Step 3 on page 13 for the Air Bleed Screw Operation.

Tip: In cold weather, cycle the Ram to warm-up the hydraulic fluid. This will provide full power from your DR 5 -TON ELECTRIC WOOD SPLITTER.

1. With a log properly loaded, and with the Air Bleed Screw open, turn ON the Electric Motor and wait a few seconds as the motor creates pressure in the hydraulic pump.

NOTE: If the Electric Motor does not start, try pushing in the Reset Button (Figure 1 on page 10).

2. Push the Operating Handle forward. The Ram will now compress the log against the wedge, splitting the log.

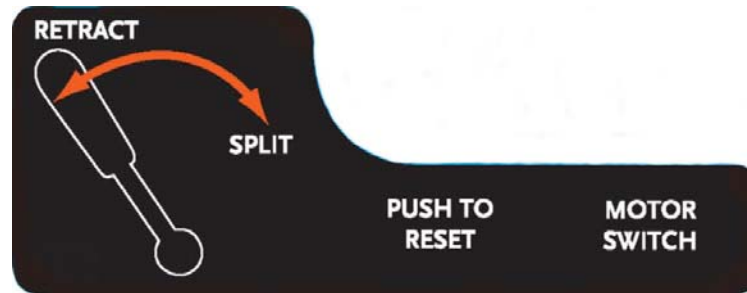

3. Keep holding the Operating Handle forward until the split pieces of the log fall away or the Ram has reached the end of its stroke. When you have finished splitting a log, release the Operator Handle. The Ram will retract to its start position.

! CAUTION!

MAKE SURE NOTHING WILL INTERFERE WITH THE RAM WHILE IT RETRACTS.

! NOTICE!

IF THE LOG DOES NOT SPLIT IMMEDIATELY, DO NOT CONTINUE THE FORWARD THRUST OF THE RAM FOR MORE THAN 5 SECONDS. THIS CAN DAMAGE THE SPLITTER. AFTER THE RAM HAS RETRACTED, TRY REPOSITIONING THE LOG ON THE SPLITTER OR SET THE LOG ASIDE.

4. Stack the split wood as you work. This will provide a safer work area by keeping it uncluttered, avoiding the danger of tripping or damaging the power cord.

How to Free a Jammed Log from the Wedge

! WARNING!

- NEVER PLACE YOUR HANDS NEAR THE LOG WHEN ATTEMPTING TO FREE IT FROM THE WEDGE.
- NEVER ASK FOR THE ASSISTANCE OF ANOTHER PERSON WHEN FREEING A JAMMED LOG.
- NEVER TRY TO EXTRACT THE JAMMED LOG BY HITTING IT WITH A TOOL; THIS COULD DAMAGE THE MACHINE.

1. Release the Operator Handle so that the Ram fully retracts (*Figure 12*).

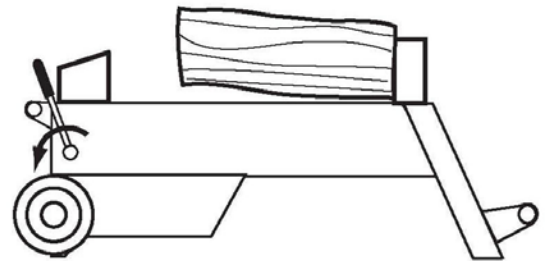

2. Insert a plastic or wooden Wedge under the jammed log (*Figure 12*) and activate the Ram to push the Wedge under the jammed log.

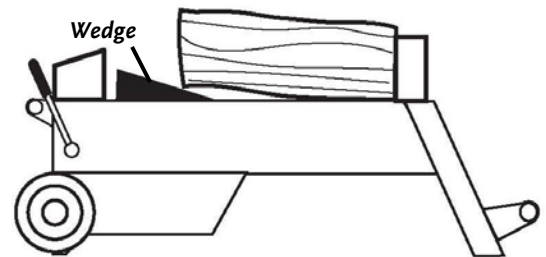

3. Repeat this process, using progressively larger Wedges, until the jammed log is free (*Figure 12*).

4. Lift the log off the wood splitter Wedge after loosening.

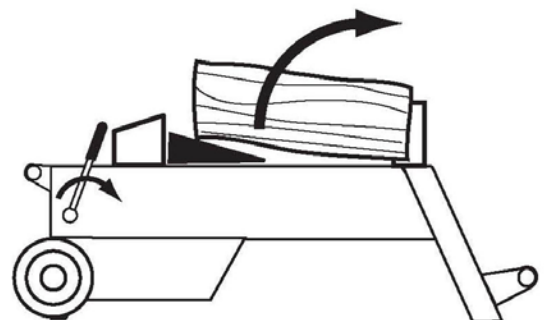

Figure 12

CHAPTER 5

MAINTAINING THE DR 5 -TON ELECTRIC WOOD SPLITTER

This chapter covers regular maintenance procedures that will ensure the best performance and long life of your wood splitter.

! WARNING!

- BEFORE PERFORMING ANY MAINTENANCE, YOU MUST UNPLUG THE WOOD SPLITTER FROM THE POWER SOURCE.
- MAKE SURE THE HYDRAULIC SYSTEM IS DEPRESSURIZED (SEE PAGE 7), AND MAKE SURE THE FLUID HAS COOLED. READ THE "GENERAL SAFETY RULES" (CHAPTER 2) OF THIS MANUAL BEFORE PERFORMING ANY REPAIRS OR MAINTENANCE.

Regular Maintenance Checklist before each use

- Clean the log Ram and Guides.
- Check the Splitting Wedge for sharpness (page 20).
- Check the general condition of the Wood Splitter, e.g.; nuts, bolts, welds (etc).
- Check that the Electric Motor Shroud is free of accumulated debris (**Figure 13**).
- Check the Ram for smooth travel.
- Check the condition of the electrical cord.



Figure 13

Before each season

- Check the hydraulic fluid level (page 20). Use AW32 hydraulic fluid for operation over 40°F and Dexron® automatic transmission fluid for operation below 40°F.

! NOTICE!

NEVER DRAIN THE HYDRAULIC FLUID. JUST ADD ENOUGH TO REPLENISH THE LOST VOLUME.

Adjusting the Hydraulic Fluid Level

NOTE: Adjust the hydraulic fluid level only if a problem suggests that the level is off; otherwise, just check the level every few months.

WARNING!

- **BEFORE PERFORMING ANY MAINTENANCE, YOU MUST UNPLUG THE WOOD SPLITTER FROM THE POWER SOURCE. MAKE SURE THE HYDRAULIC SYSTEM IS DEPRESSURIZED (SEE PAGE 7), AND MAKE SURE THE FLUID HAS COOLED.**
 - **READ THE "GENERAL SAFETY RULES" (CHAPTER 2) OF THIS MANUAL BEFORE PERFORMING ANY REPAIRS OR MAINTENANCE.**
-

Tools Needed:

- 6mm Hex Wrench (Provided)
- #3 Phillips Screwdriver

1. Depressurize the hydraulic system; see page 7.
2. Check the hydraulic fluid level by tipping the wood splitter up on the Wheels and Rear Handle.
3. Clean the area around the Hydraulic Fluid Fill/Drain Port. It is important not to let any debris enter the fluid reservoir; see **Figure 10** on page 14. Loosen the Air Bleed Screw and then, using the 6mm Hex Wrench provided, unscrew the Dipstick located in the Hydraulic Fluid Fill/Drain Port.
4. Clean the Dipstick and replace without screwing down to check the level; it should be between the two marks on the Dipstick. If the fluid is too high, simply pour out a little at a time into a suitable container by tilting the wood splitter. If the fluid is too low, add AW32 hydraulic fluid, a little at a time, until the level falls between the two marks on the Dipstick.
5. Clean the Dipstick and the O-ring seal thoroughly and reinstall, being careful not to damage the threads of the aluminum Hydraulic Fluid Cylinder End Cover.
6. Cycle the Ram back and forth 3 or 4 times to purge any air from the hydraulic system; see **Figure 9** on page 13.

Sharpening the Wedge

WARNING!

- **BEFORE PERFORMING ANY MAINTENANCE, YOU MUST UNPLUG THE WOOD SPLITTER FROM THE POWER SOURCE. MAKE SURE THE HYDRAULIC SYSTEM IS DEPRESSURIZED (SEE PAGE 7), AND MAKE SURE THE FLUID HAS COOLED.**
 - **READ THE "GENERAL SAFETY RULES" (CHAPTER 2) OF THIS MANUAL BEFORE PERFORMING ANY REPAIRS OR MAINTENANCE.**
-

Tool Needed:

- Fine-Toothed Flat File

Before each splitting session, check the sharpness of the Wedge. As required, remove any burrs or flat spots on the Wedge using a fine-toothed flat file.

Electrical Connections

WARNING!

THE DR 5 -TON ELECTRIC WOOD SPLITTER MUST BE CONNECTED TO A PROPERLY GROUNDED OUTLET BEFORE OPERATION.

End of Season and Storage

WARNING!

- BEFORE PERFORMING ANY MAINTENANCE, YOU MUST UNPLUG THE WOOD SPLITTER FROM THE POWER SOURCE. MAKE SURE THE HYDRAULIC SYSTEM IS DEPRESSURIZED (SEE PAGE 7), AND MAKE SURE THE FLUID HAS COOLED.
 - READ THE "GENERAL SAFETY RULES" (CHAPTER 2) OF THIS MANUAL BEFORE PERFORMING ANY REPAIRS OR MAINTENANCE.
-

- Wipe down the wood splitter to remove any moisture, wood chips, and dirt that may have accumulated on the Log Guide Rails and Hydraulic Control.
- Clean out any accumulated debris from the Electric Motor Shroud (*Figure 13* on page 19) and the Motor Fan Housing.
- Apply a thin coating of oil or #2 Lithium Grease to the Wedge Cutting Edge to prevent rust.
- Store the DR 5 -TON ELECTRIC WOOD SPLITTER in a dry area.
- Relieve any internal air pressure by opening the Air Bleed Screw by turning counter-clockwise 4 times and then retighten by turning clockwise prior to storing the machine; see *Figure 9* on page 13. DO NOT OVER TIGHTEN!

NOTICE!

USE CARE, DO NOT OVER TIGHTEN, AND STRIP THE AIR BLEED SCREW THREADS.

TROUBLESHOOTING

Consult the Troubleshooting Table below for common problems and their solutions. If you continue to experience problems, call our Technical Support Representatives at 1-800-DR-OWNER.

Troubleshooting Table



WARNING!

- **BEFORE PERFORMING ANY MAINTENANCE, YOU MUST UNPLUG THE WOOD SPLITTER FROM THE POWER SOURCE. MAKE SURE THE HYDRAULIC SYSTEM IS DEPRESSURIZED (SEE PAGE 7), AND MAKE SURE THE FLUID HAS COOLED.**
- **READ THE "GENERAL SAFETY RULES" (CHAPTER 2) OF THIS MANUAL BEFORE PERFORMING ANY REPAIRS OR MAINTENANCE.**

SYMPTOM	POSSIBLE CAUSE
<p><i>Ram will not move or is slow to respond.</i></p>	<ul style="list-style-type: none"> ⇒ The Air Bleed Screw may be open. See page 13, Step 3. ⇒ The motor Reset has tripped; push the Reset Button. See Figure 1 on page 10. ⇒ Bleed any accumulated air from the hydraulic system. See page 20, step 5. ⇒ The wood splitter may not be on a level surface. See page 13, step 1. ⇒ Make sure the voltage at the outlet or extension cord connection to the wood splitter is at least 105VAC. ⇒ If you are using an extension cord, make sure that the cord is less than 33 feet long and is not smaller than 12 AWG wire. ⇒ The hydraulic fluid may be low. Check and adjust the level as required; see page 20. ⇒ In extreme high temperature and heavy rapid use, the hydraulic fluid may have over heated. Allow the machine to cool. ⇒ The wood you are splitting may be too hard, it has knots, or its fiber is very tough.
<p><i>Log fails to split.</i></p>	<ul style="list-style-type: none"> ⇒ Check the possible causes for the previous Ram operation symptom. ⇒ Incorrect positioning of the log; re-position the log flat on the splitting beam with the ends squarely against the Ram face and Splitting Wedge. ⇒ Log exceeds permitted dimensions or the wood is too hard for the capacity of the machine. The maximum log length is 20" with a maximum diameter of 12" for the DR 5 -TON ELECTRIC WOOD SPLITTER. ⇒ The wedge has burrs or nicks and needs sharpening; see page 20. ⇒ There may be a hydraulic fluid leak. Locate the leak using a piece of cardboard under the machine and call 1-800-DR-OWNER (376-9637), or a qualified hydraulic mechanic for assistance, to replace worn components. ⇒ Hydraulic pressure is too low. Call 1-800-DR-OWNER (376-9637), or a qualified hydraulic mechanic for assistance to replace worn components.

! WARNING!

- BEFORE PERFORMING ANY MAINTENANCE, YOU MUST UNPLUG THE WOOD SPLITTER FROM THE POWER SOURCE. MAKE SURE THE HYDRAULIC SYSTEM IS DEPRESSURIZED (SEE PAGE 7), AND MAKE SURE THE FLUID HAS COOLED.
- READ THE "GENERAL SAFETY RULES" (CHAPTER 2) OF THIS MANUAL BEFORE PERFORMING ANY REPAIRS OR MAINTENANCE.

SYMPTOM	POSSIBLE CAUSE
<i>Ram advances with a jerky motion or with strong vibrations.</i>	⇒ Check the possible causes for the Ram operation symptom on the previous page. ⇒ Check the hydraulic fluid level; see page 20. ⇒ Bleed any accumulated air from the hydraulic system. See page 20, Step 5. If the problem persists, call 1-800-DR-OWNER (376-9637) for assistance.
<i>Hydraulic fluid leaking from the Air Bleed Screw.</i>	⇒ The wood splitter may not be on a level surface. See page 13, step 1.
<i>Hydraulic fluid leaking from the ram or other external parts.</i>	⇒ Check that the Air Bleed Screw is tight before moving the machine. Use care: Do not over tighten and strip the Air Bleed Screw Threads. ⇒ The hydraulic fluid seals may be worn. Call 1-800-DR-OWNER (376-9637) , or a qualified hydraulic mechanic for assistance to replace worn components.

PARTS LISTS, SCHEMATIC DIAGRAMS AND WARRANTY

Parts List - DR 5 -TON ELECTRIC WOOD SPLITTER

NOTE: Part numbers listed are available through Country Home Products, Inc.

<u>Ref#</u>	<u>Part#</u>	<u>Description</u>	<u>Ref#</u>	<u>Part#</u>	<u>Description</u>
Hardware :			27	215171	Front Leg
01	219891	Nut, Hex, M14	29	215151	Main Body Weldment
02	219901	Nut, Hex, M14 (Thin)	30	215161	Ram & Tie Rod Weldment
04	220031	Circlip, 30mm	31	215191	Cover, Left
06	220041	Sleeve, 45mm OD, 30mm ID, 15mm L	38	215181	Cover, Right
23	219611	Bolt, Hex Head, M8 x 16	41	215291	Filter, Screen, Brass
24	219621	Washer, Flat, M8	44	215271	Cover, Rear End, 86mm W, 126mm H
28	219991	Cap	47	215281	Shaft, Handle/Valve, Plated
32	220001	Cap, Plastic, 20mm	54	215201	Rear Cover Weldment
33	219861	Bolt, Hex Head, M8 x 10	56	215321	Bracket, Power Cord
34	220011	Cap, Plastic, 9mm	82	215211	Motor Shroud Weldment
35	219851	Bolt, Socket Head, M6 x 14	Electrical Components :		
36	219951	Washer, Flat, M6	39	219831	Screw, Cross Head, ST3.2 x 14mm coarse
40	219941	Washer, flat, M3	61	215361	Wire, Switch
43	220021	Spring, Torsion, 26mm ID	62	215401	Wire Bushing, 20mm
45	219871	Bolt, Hex Head, M8 x 25	63	215411	Wire Bushing Nut, 20mm
46	219961	Washer, Spring, M8	69	215341	Seal, Electrical Box, rubber, 135mm W x 105mm H
49	219981	Washer, Flat, Copper, M10	70	215331	Box, Electrical, 136mm W x 106mm H x 45mm D
50	219921	Nut, Hex, M10	72	215351	Pushbutton, Reset, L2, 15A
57	219971	Washer, Flat, M10	73	215381	Switch, Rocker, HY 12-9
58	219911	Nut, Hex, Acorn, Plated, M10	74	215371	Block, Wire Terminal
Components :			75	215391	Capacitor, 60uF, 300V
03	215231	Rod, Piston, 30mm OD	109	215421	Power Cord Kit:
05	215251	Spring, Compression, 44mm OD, 150mm L	62	215401	Wire Bushing, 20mm
07	215301	Dipstick, M14	63	215411	Wire Bushing Nut, 20mm
13	215261	Cover, Front End, w/Rod Hole, 82mm W x 122mm H	66	215431	Cord, 110V, 6' L
15	221001	Stud, M10 x 813mm	67	219841	Screw, Cross Head, M5 x 10
16	215311	Tube, Return, 12mm OD, 9.5mm ID, 763mm L	68	215441	Plate, Bushing, Cord, 50mm OD, 21mm ID
19	215241	Piston, Alum., 54.5mm OD, 22.0mm L			
22	215221	Main Cylinder, 60mm OD, 55mm ID, 740mm L			

<u>Ref#</u>	<u>Part#</u>	<u>Description</u>
107	215451	Motor Pump Kit:
24	219621	Washer, Flat, M8
60	215491	O-Ring, Rubber, 15.5mm OD, 10.5mm ID
64	215481	Bolt, Hex Head, M8 x 30
65	215461	Motor, Pump, Connection Box, w/out Fan Kit
71	215471	Pad, Motor Mounting, Rubber
83	219881	Bolt, Hex Head, M8 x 35
108	215501	Fan Kit:
76	215541	Screw, Cross Head, M4 x 8
77	215551	Washer, Spring, M4
78	215561	Washer, Flat, M4
79	215521	Fan, 12 Blade, Motor, 138mm OD, 20mm ID
80	215531	Circlip, External, 19mm ID
81	215511	Cover, Fan, 155mm OD, 75mm L
110	219531	Wheel Kit:
51	219551	Shaft, Wheel, 14.8mm OD, 93.5mm L
52	219541	Wheel, Molded, 7 Spoke, 5.75" OD, 2" Width
53	219561	Ring, Retaining, External, 14mm
59	219571	Bolt, Hex Head, M6 x 12
103	219581	Carry Handle Kit:
23	219611	Bolt, Hex Head, M8 x 16
24	219621	Washer, Flat, M8
55	219591	Handle, Rubber, 35mm OD, 120mm W, M8
106	219631	Operating Handle Kit:
45	219651	Bolt, Socket Head, M8 x 14
46	219961	Washer, Spring, M8
48	219641	Handle Arm w/Grip, Plated, 13mm OD, 143mm L, M8
104	219661	Rubber Foot Kit:
25	219671	Foot, Rubber, 25mm OD, 16mm H, M8
26	219681	Nut, Hex, M8

<u>Ref#</u>	<u>Part#</u>	<u>Description</u>
102	219691	Bleed Screw Kit:
11	219701	Screw, Bleed, Cross Head, M6 x 10, Plated
12	219711	Washer, Flat, Nylon, 12mm OD, 5.81mm D, 1.75mm THK
105	219721	Slide Pad Kit:
37	219731	Pad, Slide, Plastic, Flat, 75mm W, 73mm L
	219741	Seal Kit :
14	219751	Gasket, 120mm x 80mm
08	219761	Seal, Ring, Teflon, 30mm ID
09	219811	Seal, UHS, 30mm ID
10	219821	O-Ring, Rubber, 56mm OD, 50mm ID
17	219771	O-Ring, Rubber, 2.65 - 10.6mm
18	219781	O-Ring, Rubber, 3.55 - 25mm
20	219791	O-Ring, Rubber, 3.55 - 43.5mm
21	219801	Seal, Piston, Square, 55mm OD, 50mm ID, 4mm L
111	220051	Product Pack:
90	220091	Wrench, Allen Key, M6
91	220071	Wrench 13 - 16mm
92	220081	Wrench 10 - 12mm
93	220101	Seal, Washer, Dipstick, M14
101	214581	WDS 5.4 S&O Manual
		Labels:
94	211901	Label, Operating
95	211911	Label, Controls
96	206861	Label, Air Bleed Screw
97	193521A	Label, Serial Number
98	211971A	Label, Branding, Right Side
99	211931A	Label, Branding, Left Side
100	211891	Label, Safety - Warning
	220111	Packaging :
84	220121	Packing, Foam, A
85	220131	Packing, Foam, B
86	220141	Packing, Foam, C
87	220151	Packing, Foam, D
88	220161	Packing, Foam, E
89	220171	Carton, Shipping, 1055mm L, 320mm W, 535mm H

Schematic - DR 5-TON ELECTRIC WOOD SPLITTER

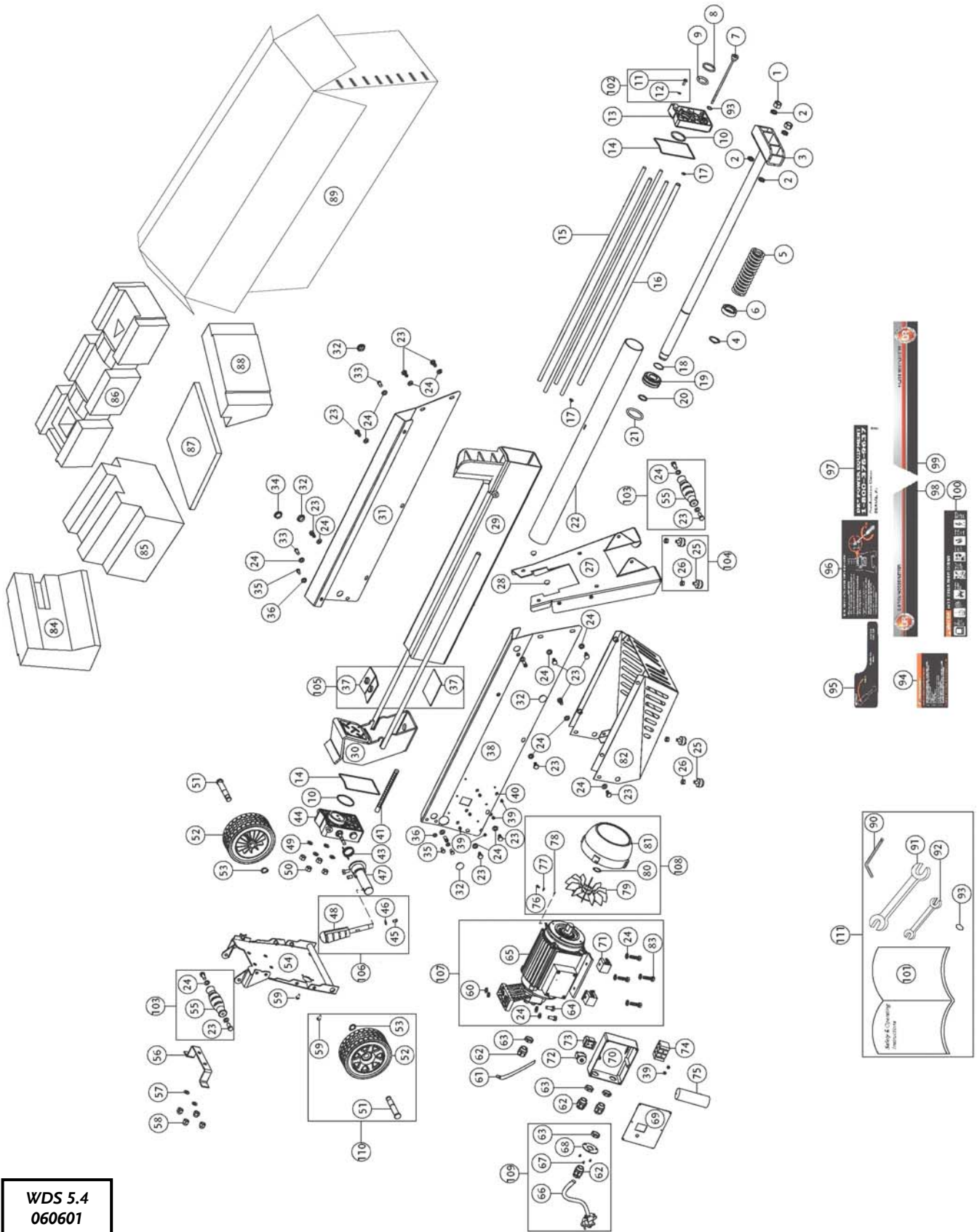

WDS 5.4
060601

Optional Accessories

The following three (3) Optional Accessories are available for your DR 5-Ton Electric Wood Splitter through Country Home Products, Inc. by calling **Toll-Free: 1-800-DR-OWNER (376-9637)**. Please refer to the Optional Accessories *Safety & Operating Instructions* Manual supplied with each accessory for the proper installation and use.



Tray



Table



Storage Clamp

Notes

DR[®] 5 -TON ELECTRIC WOOD SPLITTER



2-Year Limited Warranty Terms and Conditions

The DR[®] 5 -TON ELECTRIC WOOD SPLITTER is warranted for two (2) years against defects in materials or workmanship when put to ordinary and normal consumer use; ninety (90) days for any other use.

For the purposes of all the above warranties, "ordinary and normal consumer use" refers to non-commercial residential use and does not include misuse, accidents, or damage due to inadequate maintenance.

Country Home Products, Inc. (home of DR[®] Power Equipment) certifies that the DR[®] 5 -TON ELECTRIC WOOD SPLITTER is fit for ordinary purposes for which a product of this type is used. Country Home Products, Inc. however, limits the implied warranties of merchantability and fitness in duration to a period of two (2) years in consumer use, ninety (90) days for any other use.

The 2-Year Limited Warranty on the DR[®] 5 -TON ELECTRIC WOOD SPLITTER starts on the date the machine ships from our factory. The 2-Year Limited Warranty is applicable only to the original owner.

The warranty holder is responsible for the performance of the required maintenance as defined by the manufacturer's owner's manual. The warranty holder is responsible for replacement of normally wearing parts such as the plastic slide pads. Attachments and accessories to the machine are not covered by this warranty.

During the warranty period, the warranty holder is responsible for the machine transportation charges, if required. During the warranty period, warranty parts will ship by standard method at no charge to the warranty holder. Expedited shipping of warranty parts is the responsibility of the warranty holder.

SOME STATES DO NOT ALLOW LIMITATIONS ON THE LENGTH OF IMPLIED WARRANTIES, SO THE ABOVE LIMITATIONS MAY NOT APPLY TO YOU.

Country Home Products, Inc. shall not be liable under any circumstances for any **incidental or consequential damages or expenses** of any kind, including, but not limited to, cost of equipment rentals, loss of profit, or cost of hiring services to perform tasks normally performed by the DR[®] 5 -TON ELECTRIC WOOD SPLITTER.

SOME STATES DO NOT ALLOW THE EXCLUSION OR LIMITATION OF INCIDENTAL OR CONSEQUENTIAL DAMAGES, SO THE ABOVE LIMITATIONS MAY NOT APPLY TO YOU.

Customer Service Hotline

Country Home Products, Inc.'s objective is to have 100% satisfied customers. For that reason, we operate a 6-day-a-week Technical Service Department for our Owners. You can access a Representative by dialing our TOLL-FREE Hotline at **1-800-DR-OWNER (376-9637)**. The sole job of our well-trained and friendly folks is to ensure that you get any help you need in a timely fashion. They are there to answer all your questions including: (1) inquiries on any of the above warranties, (2) inquiries about replacement parts, or (3) your questions regarding service, maintenance, and operation.

THIS WARRANTY GIVES YOU SPECIFIC LEGAL RIGHTS, AND YOU HAVE OTHER RIGHTS, WHICH VARY FROM STATE TO STATE.

Daily Checklist for the DR 5 -TON ELECTRIC WOOD SPLITTER

To help maintain your DR 5 -TON ELECTRIC WOOD SPLITTER for optimum performance, we recommend you follow this checklist each time you use your machine.

- [] **HARDWARE:** Check all nuts and bolts to be sure that the components are secure.
- [] **FRAME:** Check all welds to be sure that the frame is in tact and secure.
- [] **CLEAN:** Make sure that the log guides and the top of the wood splitter beam are clean. Check that the Electric Motor Shroud is free of accumulated debris (**Figure 13** on page 19).
- [] **AIR BLEED SCREW:** Make sure to open the Air Bleed Screw prior to operating the wood splitter; see page 13.



COUNTRY HOME PRODUCTS, Inc.

MEIGS ROAD, P.O. BOX 25, VERGENNES, VERMONT 05491

1-800-DR-OWNER (376-9637) • www.dr-owner.com

©2006 CHP, Inc. 214581