

**DR<sup>®</sup>** R100 ENGINE

**SAFETY & OPERATING INSTRUCTIONS**



**Original Language**

DR Power Equipment  
Toll-free phone: 1-800-DR-OWNER (376-9637)  
Fax: 1-802-877-1213  
Website: [www.DRpower.com](http://www.DRpower.com)

**! WARNING**

Read and understand this manual and all instructions before operating the DR R100 ENGINE.

## Table of Contents

I: Safety Precautions .....	3
II: Parts Description .....	4
III: Pre-Operation Inspection .....	5
IV. Starting the Engine .....	7
V. Stopping the Engine .....	9
VI. Exhaust Control System.....	10
VII: Maintenance .....	10
VIII. Transport and Storage .....	14
IX: Troubleshooting.....	15
X. Specifications .....	19

### *Conventions used in this manual*

---

#### **WARNING**

This indicates a hazardous situation, which, if not avoided, could result in death or serious injury.

---

---

#### **CAUTION**

This indicates a hazardous situation, which, if not avoided, could result in minor or moderate injury.

---

---

#### **NOTICE**

This information is important in the proper use of your machine. Failure to follow this instruction could result in damage to your machine or property.

---

### *Additional Information and Potential Changes*

DR Power Equipment reserves the right to discontinue, change, and improve its products at any time without notice or obligation to the purchaser. The descriptions and specifications contained in this manual were in effect at printing. Equipment described within this manual may be optional. Some illustrations may not be applicable to your Engine.

## I: Safety Precautions

---

### **WARNING**

There is a possibility of voiding the warranty and personal or equipment damage if instructions are not followed.

---

Please pay special attention to the following:

1. Operate the engine according to the recommendations in your owner's manual. Do not overload, overrun the engine or run it with low load and at low speed for a long period of time.
2. Use regulated 87 octane brand of gas. The fuel should be fully deposited and filtrated before use. Keep the fuel filler clean to prevent contamination.
3. Change the oil periodically as described in the "Maintenance" section of this manual.
4. Periodically check the installation, connection and the tightness of the mounting hardware. Tighten when necessary.
5. Periodically clean the air filter; change it as indicated in the "Maintenance" section.
6. This gasoline engine is air-cooled, so clean the cooling fins, recoil cover and air intake to allow the engine cool normally.
7. The operator should be familiar with the working principle and structure of this gasoline engine, knowing how to make an emergency stop when needed. Do not allow anyone without training to operate the engine. Perform periodical maintenance per the "Maintenance" section. Fix all operation problems immediately. Do not run the engine if it is not operating properly.
8. Only operate the engine in a well-ventilated place, keep it at least one meter away from building walls or other equipment, keep engine away from inflammables such as gasoline, matches and so on to avoid possibility of fire.
9. Refuel in a well-ventilated area with the engine stopped, do not smoke and do not allow flames or sparks in the refueling area.
10. Do not overfill the fuel tank to avoid fuel spilling out. If there is spilled fuel around, be sure to clean it thoroughly before starting.
11. Do not run the engine inside buildings or enclosure areas.
12. The exhaust muffler is very hot during running the engine and even after the engine stops. Never touch it, or you may get burns. Do not transport or store the engine until it has cooled down entirely.
13. Safe warning label:

Please carefully read warning labels before operating. DR Power Equipment is not responsible if a person is hurt, or equipment becomes damaged due to disregarding warning labels.



## II: Parts Description

---

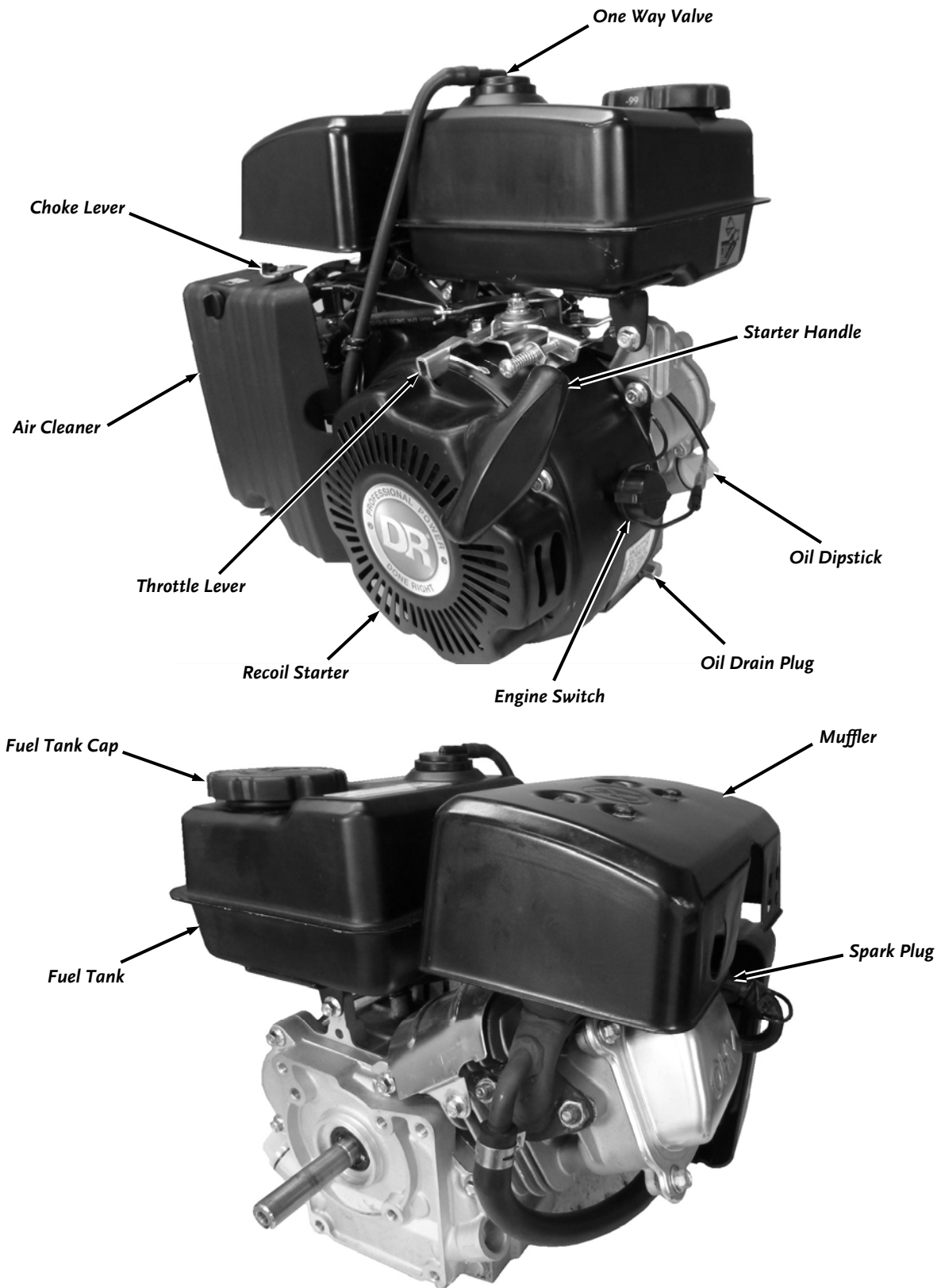

### III: Pre-Operation Inspection

---

#### 1. ENGINE OIL

##### **CAUTION**

Use 4-stroke engine oil, API service classification SJ class or equivalent. Check the API service label on the oil container to be sure it includes the letters SJ class or equivalent.

---

SAE 10W-30 is recommended for general use. Other viscosities shown in the chart may be used when the average temperature in your area is within the indicated range.

##### **Oil level check**

1. Remove the dipstick and clean it with a rag.
2. Reinsert the dipstick into the oil filling hole without screwing it in. Pull the dipstick out and check oil level.
3. If the oil level is too low, add the recommended engine oil up to the oil filling neck.
4. Reinstall the dipstick.

Oil Capacity = .37 qt/11.8 oz. (0.35L)

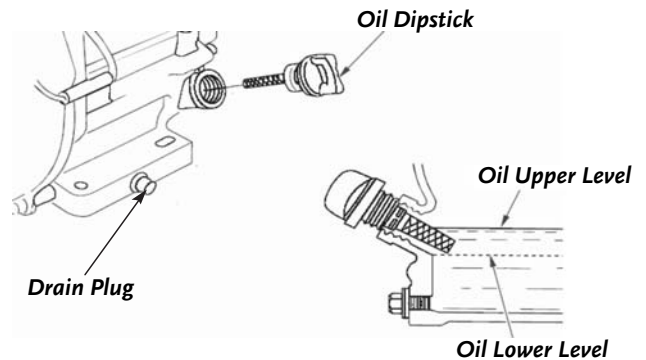
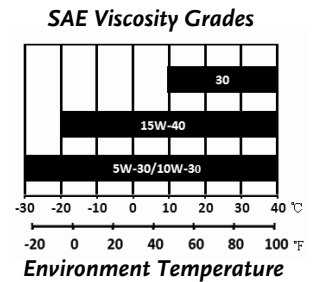

##### **NOTICE**

Running the engine with insufficient engine oil may damage the engine severely and would not be covered under warranty.

---

#### 2. AIR CLEANER

Remove the air cleaner cover and check the air filter to make sure it is clean and not damaged. Clean or replace it as necessary (see the "Maintenance" section for maintenance of the air filter).

---

##### **NOTICE**

Never run the engine without the air filter and cover installed or damage to the engine could result. Damage to the engine by not having the air filter and cover installed is not covered under warranty.

---

### 3. FUEL RECOMMENDATION

1. Remove the fuel tank cap and check the fuel level.
2. If the level is too low, refuel the tank to the recommended level. Remember to never fill fuel over the fuel filler shoulder.

---

#### **! WARNING**

- Gasoline is extremely flammable and is explosive under certain conditions.
  - Only add fuel in a well-ventilation area with the engine stopped. Do not smoke and do not allow flames or sparks in the area where gasoline is stored or where the fuel tank is refueled.
  - Do not overfill the fuel tank (there should be no fuel in the filling neck). After refueling, make sure the fuel tank cap is installed securely.
  - Be careful not to spill fuel when refueling. Spilled fuel or fuel vapor may ignite. If any fuel is spilled, make sure the area cleaned up and is dry before starting the engine.
  - Avoid repeated or prolonged contact with skin or breathing of fuel vapor. Keep out of reach of children.
- 

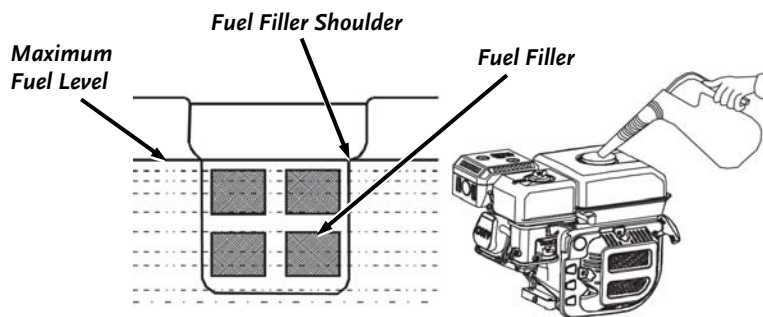

Fuel Tank Capacity = .53 gal/2.1 qt (2L)

---

#### **NOTICE**

- Fuel may damage paint and plastic. Be careful not to spill fuel when refueling. Any damage due to fuel spilling is not covered under warranty.
  - It is normal to hear a "light knocking" sound when the engine is overloaded. Do not be concerned if this occurs. If "knocking" or sounds occur at a steady speed under normal load, change the brand of gasoline; if the sounds continue, consult your dealer for help.
  - If you continue to run the engine with a "Knocking" sound during normal operation, it will damage the engine.
  - Continuing to use the engine with "Knocking" sounds from misusing will void the engine warranty.
-

## IV. Starting the Engine

---

1. Turn the choke lever to the “CHOKE” position. If the engine is hot from use, leave the choke lever in the “RUN” position.

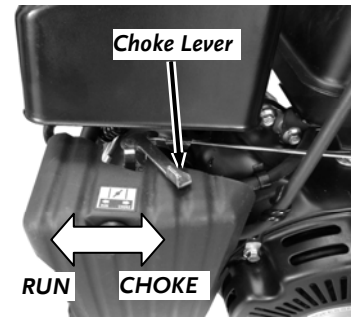

2. Move throttle lever to the left a little.

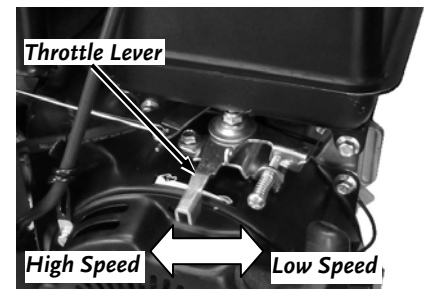

3. Starting the engine

- a. Turn the engine switch to the “ON” (START) position.

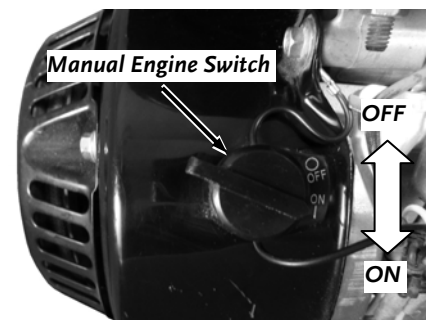

- b. Pull the recoil starter grip lightly until resistance is felt, then pull briskly.

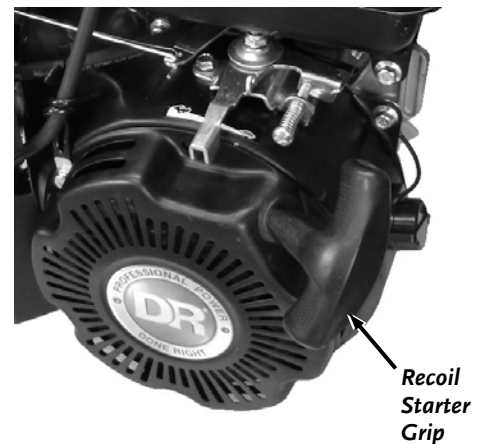

---

### NOTICE

Don't allow the recoil starter grip to snap back against the engine. Return it gently to prevent damage to the starter

---

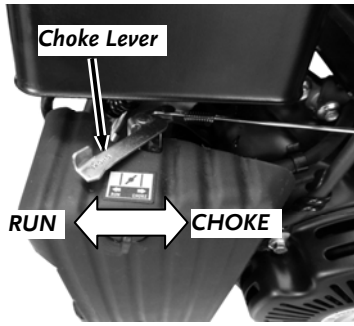

4. Once the engine is running push the choke lever to the “RUN” position.

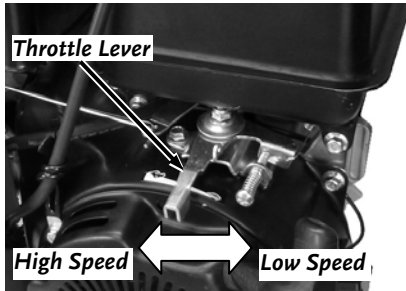

5. Move the throttle lever to proper position to make the gasoline engine run at the required speed.



## V. Stopping the Engine

---

In an emergency, rotate the engine switch to the “OFF” position.

In normal non emergency conditions, please do as follows:

1. Push the throttle lever to the right to the low speed position.

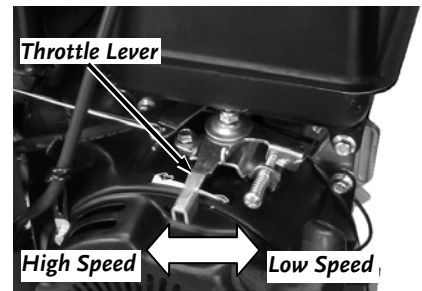

2. Rotate the engine switch to the “OFF” position.

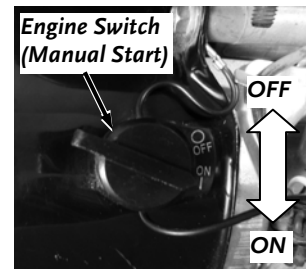

---

### **NOTICE**

Never stop the engine at high speed under heavy load unless there is an emergency because engine could be damaged.

---

## VI. Exhaust Control System

---

With the engine running, carbon monoxide, nitrogen oxide and hydrocarbons are produced, and in certain conditions, nitrogen oxide and hydrocarbon will react chemically with each other to make smoke while carbon monoxide is toxic, so proper maintenance to control these dangers is very important.

To keep the exhaust of your engine within the standard exhaust emission, pay attention to the following:

### 1. Maintenance

Maintain the engine periodically in accordance with the maintenance schedule in the “Maintenance” section. The maintenance schedule is based on normal use in normal conditions, if using under heavy load, dusty or wet circumstances or in high temperature, service of the engine should be done more often.

### 2. Problems affecting exhaust emissions

- Difficult starting or difficult stopping.
- Unstable idling speed.
- Exhausting of black smoke or consuming too much fuel.
- Poor ignition, sparks or backfire.
- Premature ignition.

If you are experiencing any of above problems, contact DR Power Equipment for help.

### **High Altitude Kit for EPAIII Engines**

3000ft to 6000ft or 6000ft to 8000ft of elevation

At high altitude, the standard carburetor air-fuel mixture will be too rich. Performance will decrease and fuel consumption will increase. A very rich mixture will also foul the spark plug and cause hard starting. Operation at an altitude that differs from that at which this engine was certified, for extended periods of time, may increase emissions.

The fuel system on this Engine or Equipment may be influenced by operation at higher altitudes. Proper operation can be ensured by installing an altitude kit when required. See the table below to determine when an altitude kit is required. Operating this engine without the proper altitude kit installed may increase the engine’s emissions and decrease fuel economy and performance. Kits may be obtained from DR Power Equipment, and should be installed by a qualified individual.

Fuel	Altitude Range*	Kit Part Number
Gasoline	0 – 3000 ft	Not Required
	3000 – 6000 ft	Altitude kit 1#
	6000 – 8000 ft	Altitude kit 2#

Engine, Generator Set, Pressure Washer, Walk-Behind Lawnmower, Compressor, Pump, Tiller etc.  
\*Elevation above sea level.

- This high altitude jet is to be used at elevations above 3000 feet.
- At elevations above 8000 feet, the engine may experience decreased performance, even with the high altitude kit.

---

### **WARNING**

To prevent serious injury from fire follow the kit procedures in a well-ventilated area away from ignition sources. If the engine is hot from use, shut the engine off and wait for it to cool before proceeding.

---

### **NOTICE**

The warranty may be void if necessary adjustments are not made for high altitude use by installing a high altitude kit.

---

If a carburetor is replaced, the proper high altitude kit jet will need to be installed into the replacement carburetor.

## VII: Maintenance

The engine must be properly maintained to ensure safe operation, economy and trouble-free, as well as eco-friendly.

In order to keep your gasoline engine in good working condition, it must be periodically serviced. The following maintenance schedule and routine inspection procedures must be carefully followed.

Frequency		Each Time Before use	First month or first 20hrs of operation	Every 3 months or every 50hrs of operation	Every year or every 100 hrs of operation
Engine oil	Check- Refill	√			
	Replace		√	√	
Air filter element	Check	√			
	Clean		√		
	Replace			√	
Spark Plug	Check - adjust				√*
Spark arrester	Clean			√	
Idling ( if equipped)* *	Check - adjust				√
Valve clearance * *	Check-adjust				√
Fuel tank & fuel filter * *	Clean				√
Fuel line	Check	Every 2 years ( change if necessary)			

\* These items should be replaced as needed.

\* \* These items should be maintained and repaired by our authorized dealer, unless the owner has appropriate tools and is proficient with mechanical maintenance.

### NOTICE

- If the gasoline engine is frequently operating under high temperature or heavy load, change the oil every 25 hours.
- If the engine is frequently operating under dusty or other severe circumstances, clean the air filter element every 10 hours; If necessary, change the air filter element every 25 hours.
- Perform maintenance according to which one come first, period (month, year) or the exact time (hours).

### WARNING

Stop the engine before servicing. Put the engine on a level surface and remove the spark plug cap to prevent the engine from starting. Never run your engine in a poorly ventilated room or other enclosed area, be sure to keep good ventilation in working area. The exhaust from the engine may contain poisonous gases, inhalation can cause shock, unconsciousness and even death.

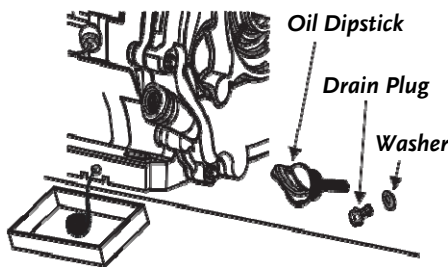

## MAINTENANCE METHOD

### 1. Replacement of engine oil (see "Oil Level Check" in Chapter III to check oil level)

The oil will drain more rapidly and completely when the engine is warm.

- (1) Remove the oil filler cap and drain plug to drain engine oil thoroughly.
- (2) Reinstall the drain plug and screw in securely.
- (3) Fill with the specified engine oil up to the upper level mark.
- (4) Reinstall the oil filler cap.

## NOTICE

Do not dump oil containers or discarded engine oil into rubbish boxes or onto the ground. For the sake of environmental protection, we suggest you take in discarded engine oil with a closed container and bring to local recycling station.

### 2. Maintenance of air filter

A dirty air filter can restrict air flowing into the carburetor. To keep the carburetor in good working condition, please service the air filter periodically (clean air filter element after 20h of use). If the engine is being operated in an extremely dusty area, clean the filter more often.

## WARNING

Never clean the air cleaner filter with gasoline or low flash-point detergents, or explosion may happen.

## NOTICE

Never run the engine without an air filter because dirt and dust entering the engine can speed up engine wear and cause damage.

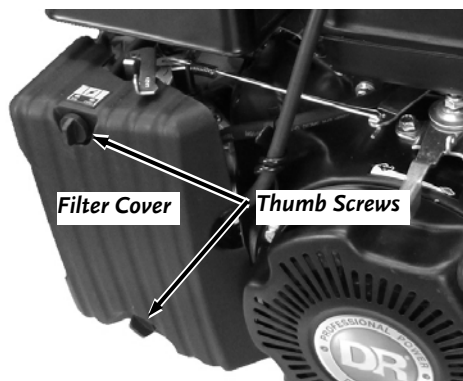

- (1) Remove the two thumb screws from the filter cover and remove the cover.
- (2) Remove the foam filter.
- (3) If the filter is damaged you must replace with a new filter.
- (4) Wash the foam filter with a mild detergent and warm water (or non-flammable or high flash-point cleansing solvents). Rinse with warm water and allow to dry completely.
- (5) Clean the air filter cover and inner surface with wet cloth, be careful not to allow the dust to enter into the carburetor.
- (6) Reinstall the air filter.
- (7) Reinstall the filter cover and secure with the two thumb screws.

### 3. Spark plug

Spark plug type: See specification section X.

To ensure the engine will run normally, the spark plug gap must be correct and make sure there are no deposits around the spark plug.

- (1) Remove the spark plug cap.
  - (2) Clear away dirt from around the spark plug base.
  - (3) Only remove the spark plug with a spark plug wrench.
  - (4) Visually check the spark plug. Clean with a steel brush. If the insulator is damaged, replace the spark plug.
  - (5) Measure the spark plug clearance with a feeler gage. The clearance should be .028" - .032" (0.7 - 0.8mm) if adjustment is necessary, bend the side electrode carefully.
  - (6) Check if the spark plug gasket is in good conditions. Screw in the spark plug as far as you can by hand to prevent thread damage.
  - (7) Tighten the spark plug with a spark plug wrench and compress the gasket.
- If a new spark plug is used, turn it 1/2 turn after compressing the gasket.
  - If reinstalling the used spark plug, turn it 1/8-1/4 turns after compressing the gasket.

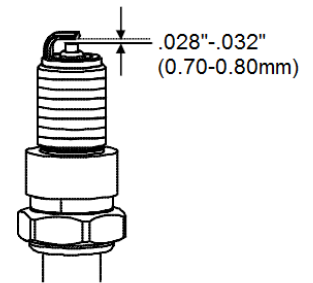
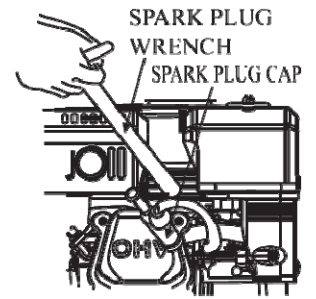

### WARNING

Don't touch the muffler when the engine is running and just gasoline engine stopping stage to avoid burn.

### **NOTICE**

The spark plug must be tightened securely or it may become very hot and damage the engine.

## VIII. Transport and Storage

Transport or store the engine only when it is cool to avoid getting burns or causing fire.

If the engine is not kept in use for a long period of time, be sure to store it properly.

### **WARNING**

Fuel is extremely flammable and explosive under certain conditions. Keep smoke, fire and spark away from operating site.

### **NOTICE**

Do not excessively tilt the engine because fuel will spill. Spilled fuel or fuel vapor may ignite to cause fire.

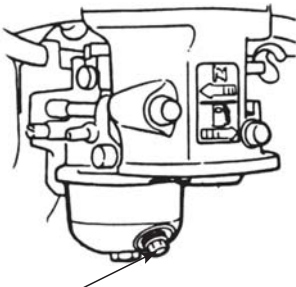

**Carburetor Drain Plug**

1. Make sure the storage area is dry and free of dust.
2. Turn the fuel shutoff to the "OFF" position and set a proper container under the carburetor.
3. Remove the carburetor drain plug to remove the fuel in the carburetor float bowl to drain gasoline out of the fuel tank.
4. Reinstall the carburetor drain plug and tighten it.
5. Remove the oil drain plug, drain the oil out of the engine and reinstall the oil drain plug.
6. Remove the spark plug. Add about a spoon-full of fresh engine oil onto the cylinder. Crank the engine with the pull cord to distribute engine oil evenly. Reinstall the spark plug.
7. Cover the engine to protect dust entering.

Please maintain according to following table when reusing after storing.

Storing time	Maintaining procedure is recommended in order to prevent starting difficulty.
1 month	No maintenance needed.
1-2 month	Drain the used gasoline out and add the fresh gasoline
2 months to 1 year	Drain the used gasoline out and add the fresh gasoline Drain the gasoline out of the carburetor cup. Drain the gasoline out of the sediment bowl.
More than 1 year	Drain the used gasoline out and add the fresh gasoline Drain the gasoline out of the carburetor cup. Drain the gasoline out of the sediment bowl. After removing from storage, first drain the used gasoline into approved container and don't start before adding fresh gasoline.
Remove the carburetor drain plug and completely drain the gasoline out of the carburetor to an approved container and replace the drain plug. Remove the sediment bowl after closing fuel shutoff and completely pour the gasoline out the sediment bowl. Finally reinstall the sediment bowl and screw it down.	

## IX: Troubleshooting

### 1. ENGINE STARTING DIFFICULTLY:

TROUBLE		CAUSE		REMEDY	
Normal cylinder compression	Normal spark plug spark	Something wrong with the fuel system.	Fuel supply is not smooth or no fuel supply.	There is not enough fuel in fuel tank and fuel shutoff is closed.	Fill fuel, open fuel shutoff.
			Air vent in the fuel filler cap is clogged	Dredge air vent.	
			Fuel shutoff is clogged	Clean first and then dredge	
			Improper or clogged main fuel flow hole.	Readjust or clean, blow to get through.	
			Needle valve is not closed properly or start hole is clogged.	Dismantle needle valve and repair, clean, blow to get through.	
			Float is damaged or sticking.	Repair float	
			Fuel supply is normal.	Fuel is too filthy or deteriorated	Replace
				There is water in fuel.	Replace
	Too much fuel in engine	Drain extra fuel, dry up spark plug electrodes.			
	Wrong fuel brand	Select proper fuel brand corresponding with the requirements.			
	Normal fuel supply system.	Normal high -- tension line	Too much carbon deposit and dirt around electrodes.	Clear away.	
			Electrodes are burn damaged seriously or insulators damaged.	Replace spark plug.	
		Normal high-tension line spark plug	Improper electrodes gap.	Adjust to proper value.	
			High-tension line is damaged.	Replace	
		Normal spark plug	Ignition coil is damaged.	Replace	
			Magneto loses magnetism.	Replace	
Abnormal gap between ignition coil and flywheel.			Adjust gap		
TROUBLE		CAUSE		REMEDY	
Abnormal cylinder compression.	Normal fuel supply system.	Normal spark plug.	Piston ring is worn to or even over its wear limit	Replace	
			Piston ring is broken.	Replace	
			Piston ring is sticking.	Clear up carbon fouling.	
			Spark plug is not installed tight or without a gasket.	Tighten with a gasket installed.	
			Air leakage between cylinder block and cylinder head.	Check cylinder gasket, and the flatness of the surface where cylinder block contacts the cylinder head	
				Tighten cylinder head bolts in proper order to proper torque.	
	Air leakage in the valves	Check valve clearance and tightness. Repair if necessary.			

If engine will still not start, contact DR Power Equipment.

## WARNING

- When testing the spark plug, never hold the high- voltage wire of the spark plug with a wet hand.
- Make sure there is no spilled fuel outside the engine and that the spark plug isn't dipped with fuel.
- To prevent fire, keep sparks far away from the spark plug mounting hole.

### 2. INSUFFICIENT ENGINE POWER OUTPUT:

TROUBLE	CAUSE		REMEDY
When increasing throttle, speed increases slow or speed decrease and engine stops running	Fuel supply system	Air in fuel line or fuel line clogged	Exhaust air or dredge fuel line
		Main oil flow hole is not adjusted properly	Readjust
		In carburetor, needle valve hole and main oil flow hole clogged.	Clean and blow to get through
		Fuel shutoff is clogged up.	Clean, replace damaged part
		Too much carbon deposit in combusting chamber.	Clear away
		Too much carbon fouling in muffler and exhaust pipe.	Clear away
		Air filter is clogged up.	Clean air filter paper element
		Intake pipe is leaking	Repair or replace
	Poor compression	Piston or cylinder or piston ring is worn	Replace worn parts
		Air leakage from the surface where the cylinder block contacts the cylinder head.	Replace cylinder gasket
		Too big or too small valve clearance.	Readjust
		Valve tightness is poor.	Repair

### 3. ENGINE NOT RUNNING SMOOTHLY:

TROUBLE	CAUSE	REMEDY
Knocking sound	Piston, cylinder or piston ring is worn excessively.	Replace worn parts
	Piston pin and piston pin hole are worn excessively.	Replace piston or piston pin
	Tie rod small head is worn excessively.	Replace tie rod
	Roller bearing for crankshaft main shaft is worn.	Replace roller bearing
Abnormal combustion	Engine is too hot	Troubleshoot reasons for hot engine
	Too much carbon deposit in combustion chamber	Clear away
	Improper gasoline brand or low gasoline quality	Replace with qualified gasoline
Spark lacking	There is water in float chamber	Clean
	improper spark plug electrodes clearance	Adjust
	Something wrong with induced coil or related parts	Check and replace damaged parts



4. ENGINE SUDDENLY STOPS RUNNING:

TROUBLE	CAUSE		REMEDY
Stops suddenly when running.	Fuel supply system	Fuel tank is empty	Refill fuel tank
		Carburetor is clogged	Check fuel line and dredge
		Float is leaking	Repair
		Needle valve is sticking	Dismantle float chamber and free up needle valve
	Ignition system	Spark plug is damaged, or short-circuited by carbon deposit	Replace spark plug
		Side electrode of spark plug is dropped out	Replace spark plug
		High-tension wire is dropped out	Weld on
		Ignition coil is punctured or short-circuited	Replace ignition coil
		Engine kill wire is touching (grounding)	Locate ground and insulate
	Engine internal	Cylinder is seriously scored and valve dropped out	Repair or replace damaged parts

5. ENGINE IS OVERHEATING

TROUBLE	CAUSE	REMEDY
Gasoline Engine Is Overheating.	Insufficient oil	Refill engine oil to proper level
	Exhaust pipe blocked up	Clean exhaust pipe
	Shroud leaking	Repair damaged part
	Cooling fins blocked by foreign matter	Clear cooling fins
	Cooling fan loose and not working	Repair cooling fan
	Connection rod deformation causing piston and cylinder bushing side wear	Replace connection rod
	Cylinder or piston or piston ring is worn and is creating heat between cylinder and crankcase	Replace the worn parts
	Improper adjustment of engine governor causing high speed.	Readjust engine governor
	Crankshaft main bearing burnt out	Replace main bearing

6. ABNORMAL NOISES WHEN ENGINE IS RUNNING

TROUBLE	CAUSE	REMEDY
Beating sound	Piston, piston ring or cylinder is worn	Replace the worn part
	Connection rod or piston pin and piston pin hole are worn	Replace the worn part
	Crankshaft main neck is worn	Replace bearing
	Piston ring is broken	Replace piston ring
Metal beating sound when abnormal combustion occurs	Too much carbon deposit in combustion chamber	Clear away carbon deposit
	Too small electrode clearance of spark plug	Adjust electrode clearance properly
	Too much fuel supplied to engine	Check relative parts such as carburetor
	Improper fuel brand	Replace fuel
	Engine is overheated	Find the cause for overheating and eliminate it
Other problems	Improper valve clearance	Readjust valve clearance properly
	Flywheel is not connected with crankshaft tightly	Connect tightly

## X. Specifications

---

<b>Model</b>	<b>R100</b>
<b>LxWxH</b>	12.2"x11.4"x12.2" (310x290x310mm)
<b>Dry Weight</b>	22 lb (10kg)
<b>Gasoline Engine Type</b>	4-Stroke, OHV, Single Cylinder, Horizontal Shaft
<b>Displacement</b>	99cc
<b>Starter</b>	Manual Recoil
<b>Compression Ratio</b>	8.3:1
<b>Bore x Stroke</b>	56x40mm
<b>Maximum Output Power</b>	1.8kW @ 3,600 rpm
<b>Maximum Torque</b>	4.7N·m @ 2,500 rpm
<b>Cooling System</b>	Forced Air-cooled
<b>Ignition System</b>	Transistorized Magneto Ignition (TCI)
<b>Spark Plug</b>	E7TC
<b>Spark Plug Clearance</b>	.028"x.032" (0.7- 0.8mm)
<b>Lubrication System</b>	Forced Splash
<b>Lubrication Type</b>	SAE15-40
<b>Oil Volume</b>	.37 qt/11.8 oz. (0.35L)
<b>Fuel Volume</b>	.53 gal/2.1 qt. (2L)
<b>Air Filter</b>	Foam
<b>Speed</b>	Manual Control
<b>Choke</b>	Manual Control
<b>PTO Shaft Rotation</b>	Counterclockwise

## Country Home Products, Inc (CHP) Engine Owner Warranty Policy

### Terms and Conditions

The DR<sup>®</sup> R100 ENGINE is warranted for two (2) years against defects in materials or workmanship when put to ordinary and normal consumer use; one (1) year for commercial use.

For the purposes of all the above warranties, "ordinary and normal consumer use" refers to non-commercial residential use and does not include misuse, accidents or damage due to inadequate maintenance.

DR Power Equipment certifies that the DR<sup>®</sup> R100 ENGINE is fit for ordinary purposes for which a product of this type is used. DR Power Equipment however, limits the implied warranties of merchantability and fitness in duration to a period of two (2) years in consumer use, one (1) year for commercial use.

The 2-Year Limited Warranty on the DR<sup>®</sup> R100 ENGINE starts on the date the machine ships from our factory. The 2-Year Limited Warranty is applicable only to the original owner.

The warranty holder is responsible for the performance of the required maintenance as defined by the manufacturer's owner's manuals. The warranty holder is responsible for replacement of normally wearing parts such as the Air Filter and Spark Plug. Accessories to the machine are not covered by this warranty.

During the warranty period, the warranty holder is responsible for the engine transportation charges, if required. During the warranty period, warranty parts will be shipped by standard method at no charge to the warranty holder. Expedited shipping of warranty parts is the responsibility of the warranty holder.

SOME STATES DO NOT ALLOW LIMITATIONS ON THE LENGTH OF IMPLIED WARRANTIES, SO THE ABOVE LIMITATIONS MAY NOT APPLY TO YOU.

DR Power Equipment shall not be liable under any circumstances for any **incidental or consequential damages or expenses** of any kind, including, but not limited to, cost of equipment rentals, loss of profit, or cost of hiring services to perform tasks normally performed by the DR<sup>®</sup> R100 ENGINE.

SOME STATES DO NOT ALLOW THE EXCLUSION OR LIMITATION OF INCIDENTAL OR CONSEQUENTIAL DAMAGES, SO THE ABOVE LIMITATIONS MAY NOT APPLY TO YOU.

THIS WARRANTY GIVES YOU SPECIFIC LEGAL RIGHTS, AND YOU ALSO HAVE OTHER RIGHTS, WHICH VARY FROM STATE TO STATE.

This Engine is manufactured for CHP by Chongqing Rato Power Manufacturing Corporation (RATO). If you have any questions please visit [www.DRPower.com](http://www.DRPower.com) or call 1-800-DR-OWNER (376-9637).

### Combined Exhaust and Evaporative Emissions Control Warranty Statement

#### YOUR WARRANTY RIGHTS AND OBLIGATIONS

The California Air Resources Board, the United States Environmental Protection Agency and Chongqing Rato Power Manufacturing Corporation (RATO), are pleased to explain the emission control system warranty on your 2014-2015 model year small off-road engine/equipment. In the United States and California, new small off-road engine/equipments must be designed, built and equipped to meet the State's stringent anti smog standards. RATO must warrant the emission control system on your small off-road engine/equipment for the periods of time listed below provided there has been no abuse, neglect or improper maintenance of your small off-road engine/equipment.

Your emission control system may include parts such as the carburetor or fuel injection system, the ignition system, catalytic converter, fuel tanks, fuel lines, fuel caps, valves, canisters, filters, vapor hoses, clamps, connectors, belts, and other associated components. For engines less than or equal to 80 cc, only the fuel tank is subject to the evaporative emission control warranty requirements of this section. (California only)

Where a warrantable condition exists, RATO will repair your small off-road engine/equipment at no cost to you including diagnosis, parts and labor.

#### MANUFACTURER'S WARRANTY COVERAGE:

#### MANUFACTURER'S WARRANTY COVERAGE:

This emissions control system is warranted for two years. If any emission-related part on your small off-road engine/equipment is defective, the part will be repaired or replaced by RATO.

#### OWNER'S WARRANTY RESPONSIBILITIES:

As the small off-road engine/equipment owner, you are responsible for the performance of the required maintenance listed in your owner's manual. RATO recommends that you retain all receipts covering maintenance on your small off-road engine/equipment, but RATO cannot deny warranty solely for the lack of receipts or for your failure to ensure the performance of all scheduled maintenance.

As the small off-road engine/equipment owner, you should however be aware that RATO may deny you warranty coverage if your small off-road engine/equipment or a part has failed due to abuse, neglect, improper maintenance or unapproved modifications.

You are responsible for presenting your small off-road engine/equipment to a RATO distribution center as soon as a problem exists. The warranty repairs should be completed in a reasonable amount of time, not to exceed 30 days.

If you have any questions regarding your warranty rights and responsibilities, you should contact Great Lakes Technologies, LLC at 1-855-206-5286 or E-mail: [service@rato-na.com](mailto:service@rato-na.com).

#### DEFECTS WARRANTY REQUIREMENTS:

(a) The warranty period begins on the date the engine/equipment is delivered to an ultimate purchaser.

(b) General Emissions Warranty Coverage. RATO warrants to the ultimate purchaser and each subsequent owner that the engine/equipment is:

- (1) Designed, built, and equipped so as to conform with all applicable regulations adopted by the Air Resources Board; and
- (2) Free from defects in materials and workmanship that causes the failure of a warranted part for a period of two years.

(c) The warranty on emissions-related parts will be interpreted as follows:

(1) Any warranted part that is not scheduled for replacement as required maintenance in the written instructions required by subsection (d) must be warranted for the warranty period defined in Subsection (b)(2). If any such part fails during the period of warranty coverage, it must be repaired or replaced by RATO according to Subsection (4) below. Any such part repaired or replaced under the warranty must be warranted for the remaining warranty period.

(2) Any warranted part that is scheduled only for regular inspection in the written instructions required by subsection (d) must be warranted for the warranty period defined in Subsection (b)(2). A statement in such written instructions to the effect of "repair or replace as necessary" will not reduce the period of warranty coverage. Any such part repaired or replaced under warranty must be warranted for the remaining warranty period.

(3) Any warranted part that is scheduled for replacement as required maintenance in the written instructions required by subsection (d) must be warranted for the period of time prior to the first scheduled replacement point for that part. If the part fails prior to the first scheduled replacement, the part must be repaired or replaced by RATO according to Subsection (4) below. Any such part repaired or replaced under warranty must be warranted for the remainder of the period prior to the first scheduled replacement point for the part.

(4) Repair or replacement of any warranted part under the warranty must be performed at no charge to the owner at a warranty station.

(5) Notwithstanding the provisions of Subsection (4) above, warranty services or repairs must be provided at all RATO distribution centers that are franchised to service the subject engine/equipments.

(6) The owner must not be charged for diagnostic labor that leads to the determination that a warranted part is in fact defective, provided that such diagnostic work is performed at a warranty station.

(7) RATO is liable for damages to other engine/equipment components proximately caused by a failure under warranty of any warranted part.

(8) Throughout the emissions warranty period defined in Subsection (b)(2), RATO must maintain a supply of warranted parts sufficient to meet the expected demand for such parts.

(9) Any replacement part may be used in the performance of any warranty maintenance or repairs and must be provided without charge to the owner. Such use will not reduce the warranty obligations of RATO.

(10) Add-on or modified parts that are not exempted by the Air Resources Board may not be used. The use of any non-exempted add-on or modified parts will be grounds for disallowing a warranty claim. RATO will not be liable to warrant failures of warranted parts caused by the use of a non-exempted add-on or modified part.

(11) RATO issuing the warranty shall provide any documents that describe that manufacturer's warranty procedures or policies within five working days of request by the Air Resources Board.

(d) Emission Warranty Parts List for exhaust (for all displacements).

(1) Fuel Metering System

(i) Carburetor and internal parts (and/or pressure regulator or fuel injection system).

(ii) Air/fuel ratio feedback and control system.

(iii) Cold start enrichment system.

(2) Air Induction System

(i) Controlled hot air intake system.

(ii) Intake manifold.

(iii) Air filter.

(3) Ignition System

(i) Spark Plugs.

(ii) Magneto or electronic ignition system.

(iii) Spark advance/retard system.

(4) Exhaust Gas Recirculation (EGR) System

(i) EGR valve body, and carburetor spacer if applicable.

(ii) EGR rate feedback and control system.

(5) Air Injection System

(i) Air pump or pulse valve.

(ii) Valves affecting distribution of flow.

(iii) Distribution manifold.

(6) Catalyst or Thermal Reactor System

(i) Catalytic converter.

(ii) Thermal reactor.

(iii) Exhaust manifold.

(7) Particulate Controls

(i) Traps, filters, precipitators, and any other device used to capture particulate emissions.

(8) Miscellaneous Items Used in Above Systems

(i) Electronic controls.

(ii) Vacuum, temperature, and time sensitive valves and switches.

(e) Emission Warranty Parts List for Evap less than or equal to 80cc.

(i) Fuel Tank.

(f) Emission Warranty Parts List for Evap greater than 80cc.

(1) Fuel Metering System

(i) Fuel Tank.

(2) Miscellaneous Items Used in Above Systems

(i) Fuel caps, valves, canisters, filters, vapor, hoses, clamps, connectors, belts, and assemblies.

RATO will furnish with each new engine/equipment written instructions for the maintenance and use of the engine/equipment by the owner.

**Notes:**



---

75 MEIGS ROAD, P.O. BOX 25, VERGENNES, VERMONT 05491