



# Battery-Powered Mower

w/Optional Attachments

## *Safety & Operating Instructions*

---

**Model: CE6.2**

**UPDATED  
MAY 2010**



### **NEUTON Power Equipment**

75 Meigs Road  
Vergennes, VT 05491

Toll-Free phone: **1-866-NEUTON1 (638-8661)**

Fax: 1-802-877-1213

Website: [www.neutonpower.com](http://www.neutonpower.com)

E-MAIL: [INFO@NEUTONPOWER.COM](mailto:INFO@NEUTONPOWER.COM)

---

**! WARNING!**

**READ AND UNDERSTAND THIS MANUAL AND ALL INSTRUCTIONS BEFORE OPERATING THIS MOWER.**

---

# Thank You!

Congratulations on your purchase of the NEUTON Battery-Powered Mower CE6.2 – the *Smart Mower for Small Lawns*.

The design of the NEUTON Mower CE6.2 uses state-of-the-art Battery technology to make mowing your lawn as easy and enjoyable as possible.

If you have not already ordered it, be sure to try the CE6.2's Trimmer Attachment, too. This option makes the CE6.2 the only mower that can also trim and edge your lawn – saving you steps, plus a whole garage full of separately powered equipment.

Please visit our website at [www.neutronpower.com](http://www.neutronpower.com) or call us, toll-free, at **1-866-NEUTON1 (638-8661)** if you have any questions or difficulties as you get used to your new mower.

We also hope to hear from you on how much you like your new helper!

Thanks once again!



**Director, Customer Relations**

for all of us at...  
Neuton Power Equipment



## **NEUTON® Power Equipment**

75 Meigs Road  
P.O. Box 25  
Vergennes, VT 05491

Toll-Free phone: **1-866-NEUTON1 (638-8661)**

Fax: 1-802-877-1213

Web site: [www.neutronpower.com](http://www.neutronpower.com)

E-mail: [info@neutronpower.com](mailto:info@neutronpower.com)

### ***Copyrights and Trademarks***

©2010 Neuton Power Equipment  
NEUTON and NEUTON logo are trademarks of Neuton Power Equipment  
All rights reserved.

### ***Documentation***

Produced in Taiwan R.O.C. exclusively for Neuton Power Equipment and meets CPSC Blade Safety requirements.

# Table of Contents

<b>Chapter 1: Introducing the NEUTON Mower CE6.2 .....</b>	<b>1</b>
About this Manual .....	1
Conventions used in this Manual.....	2
<b>Chapter 2: Important Safety Considerations .....</b>	<b>3</b>
Safety and Information Labels .....	3
Protecting Yourself and Those around You .....	5
Dressing Appropriately.....	5
Preparing to Use Your Mower or Trimmer.....	6
Operating Your Mower or Trimmer Safely.....	7
Handling the Battery Safely.....	8
<b>Chapter 3: Setting Up Your NEUTON Mower .....</b>	<b>9</b>
NEUTON Mower Package Checklist.....	9
Assembling Your NEUTON Mower .....	11
Controls and Features .....	18
Neuton CE6.2 Product Specifications .....	21
<b>Chapter 4: Operating Your NEUTON Mower .....</b>	<b>23</b>
Pre-Start Checks .....	23
Adjusting the Cutting Height .....	24
Mowing on Slopes.....	24
Starting the Motor and Engaging the Blade .....	25
Starting the Mower .....	25
Stopping the Motor and Blade .....	26
When Finished Mowing.....	26
Mowing and Lawn Care Tips.....	26
<b>Chapter 5: Charging and Caring for the Battery .....</b>	<b>27</b>
The Battery .....	27
Charging the Battery .....	28
Charging with the Battery out of the Mower.....	29
Disconnecting the Charger .....	29
Recharging after each use of the Mower .....	30
Recharging to Full Charge for Off-Season Storage.....	31
Caring for the Battery .....	32
Recycling your Used Battery .....	32
<b>Chapter 6: Optional Attachments .....</b>	<b>33</b>
NEUTON Trimmer .....	33
Striper Roller .....	33
Spare Battery .....	33
Spare Aero Cutting Blade.....	33
Blade Sharpener .....	34
<b>Chapter 7: Servicing and Storing Your NEUTON Mower .....</b>	<b>35</b>
Servicing Your Mower .....	35
Cleaning Your Mower.....	36
Cleaning the Handlebar .....	36
Removing and Attaching the Blade .....	37
Sharpening the Blade.....	38
Balancing the Blade .....	39
Storing Your NEUTON Mower .....	40
<b>Chapter 8: Troubleshooting Tips .....</b>	<b>41</b>

Troubleshooting Table .....	41
<b>Chapter 9: Optional MA 3.6 Trimmer and MA 5.6 Striper Roller .....</b>	<b>45</b>
Safety and Information Labels .....	45
Operating Your Trimmer Safely .....	46
Trimming on Slopes Safely .....	46
Using the NEUTON Trimmer .....	46
Attaching, Removing and Using the Trimmer .....	47
Adjusting the Trimmer Head .....	48
Starting the Trimmer .....	49
Stopping the Trimmer .....	49
Advancing the Cord .....	50
Safety Tips for using the Trimmer .....	50
Maintaining and Storing the NEUTON Trimmer .....	51
Replacing the Spool .....	51
Replacing the Spool Housing .....	51
Cleaning the Trimmer .....	52
Attaching and Using the Striper Roller .....	52
<b>Chapter 10: Parts Lists, Schematic Diagrams, and Warranty .....</b>	<b>55</b>
Parts List - NEUTON CE6.2 Mower .....	55
Schematic Diagrams - NEUTON CE6.2 Mower .....	59
Parts List - Optional MA 3.6 Trimmer .....	61
Schematic Diagram - Optional MA 3.6 Trimmer .....	61

# Chapter 1: Introducing the NEUTON Mower CE6.2

---

Congratulations on purchasing your new NEUTON Mower CE6.2. The advanced technology built into your NEUTON Mower makes lawn care easy and enjoyable, year after year. As you get to know your NEUTON Mower, you will discover that it is strong, light, easy to maintain, and whisper quiet. It is clean, too, because it runs on a Battery. You will breathe easy and keep your lawn beautiful the smart, fun way – with your NEUTON Mower.

These *Safety & Operating Instructions* explain how to set up and safely operate your new NEUTON Battery-Powered Mower, Model CE6.2. Carefully adhering to the *Safety & Operating Instructions* in this manual will ensure many years of productive use.

Please let us know if you have any questions. Just visit our web site at [www.neutonpower.com](http://www.neutonpower.com) or call Toll-Free **1-866-NEUTON1 (638-8661)**; our Technical Support Department will be happy to help you. When you call, please have your serial number, or order number available so we can help you quickly.

## About this Manual

### **Chapter 1:** Introducing the NEUTON Mower CE6.2

- Explains the organization of, and conventions used, in this manual.
- Provides contact information for Neuton Power Equipment

### **Chapter 2:** Important Safety Considerations

- Describes the Safety Labels on your Mower.
- Explains guidelines for safely operating your Mower.

### **Chapter 3:** Setting up your NEUTON Mower

- Describes the contents of the Mower package as shipped.
- Explains how easy the Mower is to set up.
- Describes and explains the Mower's features and controls.

### **Chapter 4:** Operating your NEUTON Mower

- Provides instructions for starting and stopping your Mower.
- Explains how to adjust the Mower's Cutting Height.
- Offers useful tips when using your Mower to care for your lawn.

### **Chapter 5:** Charging and caring for the Battery

- Explains how to use and care for the Battery that powers your NEUTON Mower.

### **Chapter 6:** Optional Attachments

- Describes the Attachments available for use with your NEUTON Mower, and how to use them.

### **Chapter 7:** Servicing and storing your NEUTON Mower

- Provides tips on servicing your Mower.
- Describes how to best store your Mower.

### **Chapter 8:** Troubleshooting Tips

- Lists common problems and their solutions.

### **Chapter 9:** Optional MA 3.6 Trimmer and MA 5.6 Striper Roller

- Explains the operation, use, and servicing of the Optional Trimmer and Striper Roller.

In addition to these chapters, the manual includes Parts Lists, Schematic Drawings of the NEUTON Mower, Trimmer and Striper Roller, a section for your notes, the Warranty, and a Check List of daily servicing procedures (on the back cover) to help you keep your Mower performing well for years to come.

## Conventions used in this Manual

---

### **WARNING!**

THIS INDICATES A HAZARDOUS SITUATION, WHICH, IF NOT AVOIDED, COULD RESULT IN DEATH OR SERIOUS INJURY.

---

### **CAUTION!**

THIS INDICATES A HAZARDOUS SITUATION, WHICH, IF NOT AVOIDED, COULD RESULT IN MINOR OR MODERATE INJURY.

---

### **NOTICE**

THIS INFORMATION IS IMPORTANT IN THE PROPER USE OF YOUR MOWER. FAILURE TO FOLLOW THIS INSTRUCTION COULD RESULT IN DAMAGE TO YOUR MACHINE OR PROPERTY.

---



This is a helpful hint to guide you in getting the most out of your NEUTON Mower.

**NOTE:** *This information may be helpful to you in using your Mower.*

**Tools Needed:** This indicates you will need a special tool to perform a maintenance function on your Mower.

**NOTE:** Neuton Power Equipment reserves the right to discontinue, change, and improve its products at any time without notice or obligation to the purchaser. The descriptions and specifications contained in this manual were in effect at printing. Equipment described within this manual may be optional. Some illustrations may not be applicable to your machine.

# Chapter 2: Important Safety Considerations

We want you to enjoy years of safe and productive use from your NEUTON Battery-Powered Mower. We do not want you injured, so please take a few moments to read the following instructions for safely operating your new machine.

## NOTICE

PLEASE READ THESE INSTRUCTION AND WARNING LABELS BEFORE USING YOUR MOWER.

## Safety and Information Labels

You will find the following labels on your NEUTON Mower.

### OPERATING INSTRUCTIONS

#### BEFORE STARTING

- Make sure blade and handlebar are in place and securely attached.
- Depending on use, attach either side discharge, mulching plug or rear bagger.
- Adjust wheel height to appropriate cutting level.
- Adjust handlebar height to comfortable level.
- Place fully charged battery in battery compartment.

#### STARTING

- Insert Safety Key into slot under battery cover.
- Set Power/Mode Switch to Mow Position.
- Light on handlebar should be green (indicating key and charged battery are in place and Power/Mode switch has been set).
- Battery Level Indicator should be in green zone (assuming battery is fully charged).
- Slide orange knob (#1) to left.
- Squeeze orange Operator Presence Control Bar (#2) and hold in place.

#### STOPPING

- Release Operator Presence Control Bar.
- Set Power/Mode Switch to off position.
- Remove Safety Key.
- Before restarting, allow motor to fully stop.

CE 6.2  
237381

Meets CPSC blade safety requirements  
Produced in Taiwan ROC exclusively for Neuton® Power Equipment.

Neuton® Power Equipment, Inc.  
Meigs Road, P.O. Box 25  
Vergennes, Vermont 05491  
1-866-NEUTON1 www.myneuton.com



Operating Instructions Label (237381)

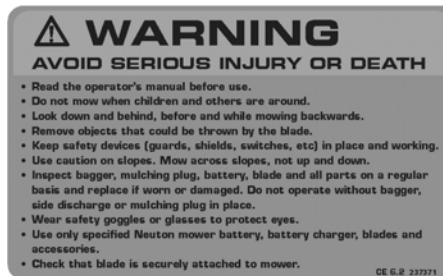

WARNING Label (237371)



WARNING Label (237571)



Danger Label (237561)

### SAFETY KEY

Safety Key Label (237501)

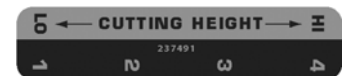

Cutting Height Label (237491)

### TO OPTIMIZE THE PERFORMANCE OF THE CE6 MOWER:

- Set cutting height to cut only a maximum of 1/3 of the grass length at any time.
- Keep the blade sharp—check blade periodically and either sharpen or replace blade as needed.
- Do not overload battery—If Battery Level Indicator momentarily drops into the red zone then either raise cutting height or slow down cutting speed. If Indicator continues to run in red zone then stop mowing and charge the battery.
- Recharge battery as soon as possible after every use—Start mowing with a fully charged battery
- Clean deck of grass clipping and debris.
- See the CE6 A&O Manual for details on each of these items.

237531

Performance Tips Label (237531)

The following Information labels are located on the Battery and the Battery slot edge.

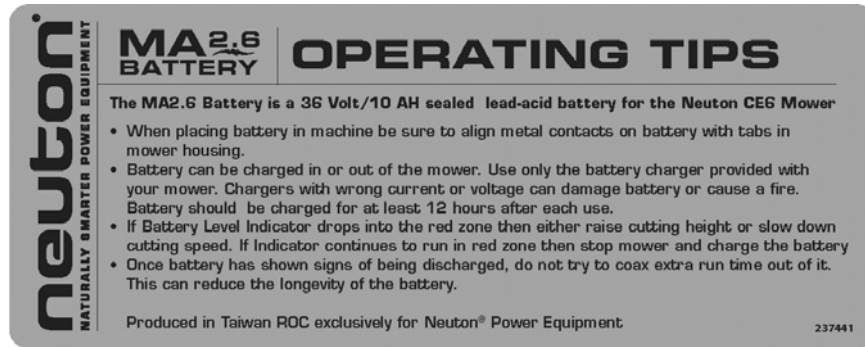

*Battery Operating Tips Label (237441)*



*Battery Insertion Label (196021)*

The following WARNING label is located on the Bagger.



*Bagger WARNING Label (237451)*

The following WARNING label is located on the Battery Charger.

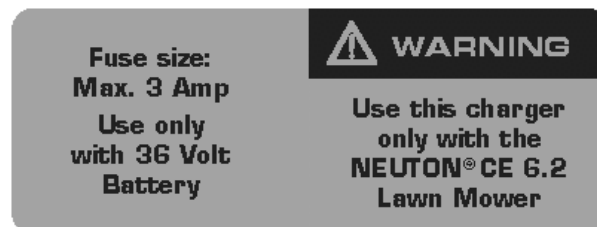

*Battery Charger WARNING Label (237521)*



# Protecting Yourself and Those around You

Tragic accidents can occur if the operator is not alert to the presence of children. Children are often attracted to the Mower and the activity of mowing or trimming. Never assume that children will remain where you last saw them.

---

## **WARNING!**

- **THIS CUTTING MACHINE IS CAPABLE OF AMPUTATING HANDS AND FEET, AND THROWING OBJECTS. FAILURE TO OBSERVE THE FOLLOWING SAFETY INSTRUCTIONS COULD RESULT IN SERIOUS INJURY OR DEATH.**
  - **BE SURE THE AREA IS CLEAR OF OTHER PEOPLE BEFORE MOWING OR TRIMMING. NEVER ALLOW CHILDREN, OTHER BYSTANDERS, OR PETS IN YOUR WORK AREA WHEN OPERATING THE MOWER OR TRIMMER. STOP THE MACHINE IF ANYONE ENTERS THE AREA.**
  - **KEEP CHILDREN OUT OF THE WORK AREA AND UNDER THE WATCHFUL CARE OF A RESPONSIBLE ADULT.**
  - **BE ALERT AND TURN THE MACHINE OFF IF CHILDREN ENTER THE AREA.**
  - **ONLY ALLOW RESPONSIBLE INDIVIDUALS WHO HAVE A THOROUGH UNDERSTANDING OF THESE INSTRUCTIONS TO OPERATE THE MOWER OR TRIMMER. NEVER ALLOW CHILDREN TO OPERATE THE MACHINE.**
  - **BEFORE AND WHILE PULLING THE MACHINE BACKWARDS, LOOK BEHIND AND DOWN FOR SMALL CHILDREN AND FOR SECURE FOOTING.**
  - **USE EXTRA CARE WHEN APPROACHING BLIND CORNERS, SHRUBS, TREES, OR OTHER OBJECTS THAT MAY OBSCURE YOUR VISION.**
  - **IF YOU ARE EVER UNSURE ABOUT AN ACTION YOU ARE ABOUT TO TAKE, PLEASE DO NOT DO IT.**
- 

## Dressing Appropriately

---

## **WARNING!**

- **ALWAYS WEAR PROTECTIVE GOGGLES OR SAFETY GLASSES WITH SIDE SHIELDS WHEN USING YOUR NEUTON MOWER OR TRIMMER TO PROTECT YOUR EYES FROM POSSIBLE THROWN OBJECTS. USE A FACE OR DUST MASK WHEN OPERATING IN DUSTY CONDITIONS.**
  - **WEAR SHOES WITH NON-SLIP TREADS WHEN USING YOUR MACHINE. IF YOU HAVE SAFETY SHOES, WEAR THEM. DO NOT USE THE MOWER OR TRIMMER WHILE BAREFOOT OR WEARING OPEN SANDALS.**
  - **WEAR LONG PANTS WHILE TRIMMING AND MOWING.**
  - **AVOID WEARING LOOSE CLOTHING OR JEWELRY, WHICH MIGHT CATCH ON THE MACHINE'S MOVING PARTS.**
-

# Preparing to Use Your Mower or Trimmer



## **WARNING!**

- **READ, UNDERSTAND, AND FOLLOW ALL INSTRUCTIONS ON THE MACHINE AND IN THE MANUAL. BE THOROUGHLY FAMILIAR WITH THE CONTROLS AND THE PROPER USE OF THE MOWER AND TRIMMER BEFORE STARTING.**
- **NEVER OPERATE THE NEUTON MOWER OR TRIMMER WITHOUT THE PROPER GUARDS, SAFETY SWITCHES, OR OTHER SAFETY AND PROTECTIVE DEVICES IN PLACE AND PROPERLY CONNECTED. INSPECT THE MACHINE AND CUTTING BLADE (OR TRIMMER CORD) TO DETERMINE PROPER INSTALLATION OF THESE DEVICES, AND THEY ARE IN GOOD REPAIR, AND OPERATE PROPERLY. IF THE CONDITION OR OPERATION OF THESE DEVICES IS QUESTIONABLE, YOU MUST REPAIR THEM OR REPLACE THEM BEFORE USING THE MACHINE.**
- **FOLLOW THE INSTRUCTIONS FOR THE PROPER INSTALLATION AND OPERATION OF ACCESSORIES. USE ONLY ACCESSORIES APPROVED BY THE MANUFACTURER. DO NOT ALTER ANY ASPECT OF THE MOWER, ATTACHMENTS, OR ACCESSORIES IN ANY WAY. MODIFYING OR CHANGING YOUR MOWER OR ITS ATTACHMENTS AND ACCESSORIES IN ANY WAY COULD CAUSE PERSONAL INJURIES AND PROPERTY DAMAGE, AND WILL VOID YOUR WARRANTY.**
- **THOROUGHLY INSPECT THE AREA WHERE YOU WILL BE USING THE MOWER OR TRIMMER, AND REMOVE ALL STONES, LAWN TOYS, WIRE, BONES, STICKS, PET SUPPLIES, AND ANY OTHER FOREIGN OBJECTS WHICH COULD BE PICKED UP AND THROWN BY THE MOWER BLADE OR TRIMMER CORD. OBJECTS STRUCK BY THE MOWER BLADE OR TRIMMER CORD CAN CAUSE SEVERE INJURIES. ALSO, NOTE THE LOCATION OF HOLES, RUTS, BUMPS, STUMPS, AND OTHER POSSIBLE HAZARDS TO AVOID.**
- **NEVER TURN THE MOWER OVER WHILE THE MOTOR IS RUNNING. THE BLADE MAY THROW OBJECTS OR COME LOOSE AND CAUSE INJURY.**
- **MOW OR TRIM ONLY IN DAYLIGHT OR IN AN AREA WELL LIT BY ARTIFICIAL LIGHT.**
- **DO NOT CHARGE THE MOWER BATTERY IN WET OR RAINY CONDITIONS.**

# Operating Your Mower or Trimmer Safely

Your Mower can operate as a Discharging, Mulching, or Bagger Mower. Learn how to use the Side Discharge Chute, Mulching Plug, and Rear Bagger as appropriate.

## **WARNING!**

- ALWAYS STOP THE MOTOR, WAIT FOR THE BLADE OR CORD TO STOP MOVING, AND REMOVE THE SAFETY KEY WHENEVER YOU LEAVE THE OPERATING POSITION (BEHIND THE HANDLEBAR) FOR ANY REASON. IN ADDITION, REMOVE THE BATTERY WHEN INSPECTING AND CLEANING THE MACHINE, PERFORMING ROUTINE MAINTENANCE, CLEARING GRASS, MAKING ADJUSTMENTS, AND ATTACHING OR REMOVING ACCESSORIES.
- NEVER INSERT THE SAFETY KEY INTO THE MOWER UNTIL YOU ARE READY TO OPERATE THE MOWER. STORE THE SAFETY KEY AWAY FROM CHILDREN AND PEOPLE NOT AUTHORIZED TO USE THE MOWER.
- THE CUTTING BLADE OR CORD ALWAYS TURNS WHEN THE MOTOR IS RUNNING. LEARN HOW TO QUICKLY STOP THE MACHINE'S MOTOR – SIMPLY RELEASE THE ORANGE CONTROL BAR. REMEMBER THAT THE BLADE OR CORD WILL CONTINUE TO ROTATE FOR UP TO THREE (3) SECONDS AFTER YOU RELEASE THE ORANGE BAR.
- DO NOT PUT YOUR HANDS OR FEET NEAR OR UNDER THE ROTATING BLADE OR CORD. KEEP CLEAR OF THE DISCHARGE AREA AT ALL TIMES.
- NEVER OPERATE THE MOWER OR TRIMMER IN THE RAIN OR WHEN THE GRASS IS WET. ALWAYS BE SURE OF YOUR FOOTING.
- KEEP A FIRM HOLD ON THE HANDLEBAR, AND WALK – NEVER RUN.
- STAY ALERT AND WATCH WHAT YOU ARE DOING.
- WATCH OUT FOR TRAFFIC WHEN MOWING OR TRIMMING NEAR ROADWAYS.
- STOP THE MOTOR WHEN CROSSING OVER LOOSE MATERIALS SUCH AS GRAVEL DRIVES, WALKS, OR ROADS, AS OBJECTS DISCHARGED BY THE MOWER OR TRIMMER CAN BE HAZARDOUS.
- DO NOT OPERATE THE MACHINE WHEN YOU ARE TIRED OR UNDER THE INFLUENCE OF MEDICATION, DRUGS, OR ALCOHOL.
- REMOVE THE SAFETY KEY WHEN THE MACHINE IS NOT IN USE.

## **CAUTION!**

- KEEP THE BLADE CUTTING EDGES SHARP AND CLEAN FOR THE BEST AND SAFEST PERFORMANCE. KEEP ALL NUTS, BOLTS, AND SCREWS TIGHT TO BE SURE THE MOWER IS IN SAFE OPERATING CONDITION. FOLLOW THE INSTRUCTIONS IN THIS MANUAL FOR CHANGING ACCESSORIES.
- NEVER PULL THE MOWER OR TRIMMER TOWARD YOU WHILE CUTTING GRASS. BY DESIGN, YOU SHOULD ONLY PUSH THE NEUTON MOWER OR TRIMMER FORWARD WHILE CUTTING.
- USE EXTREME CAUTION WHEN MANEUVERING BACKWARDS. ALWAYS STOP THE MOTOR, LOOK FIRST TO CHECK YOUR FOOTING, LOOK DOWN AND BEHIND YOU BEFORE MOVING BACKWARDS.
- IF YOU STRIKE A FOREIGN OBJECT, OR IF THE MOWER OR TRIMMER VIBRATES ABNORMALLY, STOP THE MOTOR, REMOVE THE SAFETY KEY, AND INSPECT THE MACHINE FOR ANY DAMAGE. REPAIR THE DAMAGE BEFORE RESTARTING AND OPERATING THE MACHINE. STRIKING AN OBJECT MAY LOOSEN THE BLADE. *NOTE: Excessive vibration is generally a sign of trouble.*
- DO NOT USE YOUR NEUTON MOWER OR TRIMMER FOR ANY JOB OTHER THAN THE INTENDED USE.
- ONLY USE THE TRIMMER FOR TRIMMING GRASS, WEEDS, AND OTHER VEGETATION.
- DO NOT OPERATE THE MACHINE IF IT DOES NOT START NORMALLY OR STOP NORMALLY WHEN YOU RELEASE THE CONTROL BAR.
- EMPTY THE REAR BAGGER OF ALL DEBRIS FOLLOWING EACH USE. THE FABRIC WILL WEAR AND DETERIORATE UNDER NORMAL USAGE. BEFORE EACH USE, CHECK THE BAGGER FOR WEAR AND REPLACE IF IT IS TORN, OR WORN.

# Handling the Battery Safely

## **WARNING!**

- NEVER CHARGE THE LAWN MOWER BATTERY IN THE RAIN OR IN WET CONDITIONS.
- USE ONLY AN APPROVED 36-VOLT NEUTON CHARGER TO CHARGE THE BATTERY. MAKE SURE THAT THE NEUTON CHARGER OUTPUT VOLTAGE PRINTED ON THE CHARGER LABEL MATCHES THE VOLTAGE OF YOUR BATTERY. USE OF A DIFFERENT CHARGER MAY NOT ALLOW THE BATTERY TO FULLY RECHARGE AND MAY CAUSE A FIRE OR EXPLOSION. USE OF A NON-APPROVED NEUTON CHARGER WILL VOID YOUR WARRANTY.
- EXERCISE CARE IN HANDLING THE BATTERY IN ORDER NOT TO SHORT-CIRCUIT IT WITH CONDUCTING MATERIALS SUCH AS RINGS, BRACELETS, AND KEYS. WHEN SHORT-CIRCUITED, THE BATTERY OR CONDUCTOR MAY OVERHEAT AND CAUSE BURNS.
- NEVER ATTEMPT TO ALTER OR OPEN THE BATTERY. OPENING YOUR BATTERY WILL VOID YOUR WARRANTY AND COULD RESULT IN AN UNSAFE CONDITION OR RISK OF PERSONAL INJURY. USE NORMAL HOUSEHOLD VOLTAGE (110 VOLTS) WHEN CHARGING THE BATTERY. PLUG THE CHARGER DIRECTLY INTO THE ELECTRICAL OUTLET.
- NEVER ATTEMPT TO REPLACE THE INDIVIDUAL BATTERY CELLS INSIDE THE BATTERY. MIXING FRESH AND DISCHARGED BATTERIES COULD INCREASE INTERNAL CELL PRESSURE AND RUPTURE THE DISCHARGED BATTERY. IMPROPER WIRING WITHIN THE BATTERY COULD RESULT IN LEAKAGE OR EXPLOSION.
- NEVER DISPOSE OF BATTERIES IN A FIRE, AS THE BATTERY CELLS MAY EXPLODE. NEVER OPEN OR MUTILATE THE BATTERY. RELEASED ELECTROLYTE (BATTERY ACID) IS CORROSIVE AND WILL CAUSE DAMAGE TO EYES, SKIN, OR CLOTHES. BATTERY ACID IS TOXIC IF SWALLOWED OR IF THE FUMES ARE INHALED.
- NEVER THROW AWAY USED BATTERIES IN YOUR HOUSEHOLD TRASH. BRING THEM TO A RECYCLING CENTER OR HOUSEHOLD HAZARDOUS WASTE DEPOT FOR PROPER DISPOSAL. PLEASE REFER TO "RECYCLING YOUR USED BATTERY" ON PAGE 31 FOR MORE INFORMATION.

**NOTE:** See additional details on Battery care in "Chapter 5: Charging and Caring for the Battery".

No list of Warnings and Cautions can be all-inclusive. If situations occur not covered by this manual, the operator must apply common sense and operate the NEUTON Mower or Trimmer in a safe manner. Visit our website at [www.neutonpower.com](http://www.neutonpower.com) or call **1-866-NEUTON1 (638-8661)** for assistance.

# Chapter 3: Setting Up Your NEUTON Mower

---

This chapter outlines a few simple steps needed to set up your new Mower. Before beginning assembly, it may be helpful to familiarize yourself with the controls and features on your Mower by reviewing the photograph of the Mower on page 17 (**Figure 15**) and reading about the Mower's controls and features.

Please check that you have all of the components listed below. If anything is missing, please visit our website at [www.neutonpower.com](http://www.neutonpower.com) or call Neuton Power Equipment Toll-Free at: **1-866-NEUTON1 (638-8661)**.

## NEUTON Mower Package Checklist

Neuton Power Equipment ships the following items (**Figure 1** on page 10) in your Mower package. Please check to make sure you have everything listed below:

- NEUTON CE6.2 Battery-Powered Mower
- Side Discharge Chute w/Handle and Mounting Screw
- Rear Bagger
- Mulching Plug
- Battery (inside the Mower)
- Battery Charger
- Safety Key
- 36mm Wrench (to remove the Blade)
- 3/4" Wrench (to remove the Blade)
- NEUTON CE6.2 Battery-Powered Mower *Safety & Operating Instructions* Manual



**NEUTON CE 6.2 Mower**



**Mulching Plug**



**Side Discharge Chute  
(shown w/ Handle mounted)**



**Bagger**



**Battery**



**Battery Charger**



**Safety Key**



**36mm Wrench  
&  
3/4\"/>**

**Figure 1**

# Assembling Your NEUTON Mower

To allow you to quickly begin using your NEUTON Mower, it shipped to you partially assembled. The assembly process is easy and does not require any special tools, knowledge, or strength.

Assembling your NEUTON Mower takes just a few steps:

**Step 1:** Read the *Safety & Operating Instructions* before proceeding

**Step 2:** Adjust the Handlebar Height

**Step 3:** Remove the Battery

**Step 4:** Charge the Battery before your first use

**Step 5:** Attach the Side Discharge Chute, Mulching Plug, or Rear Bagger

**Step 6:** Insert the Battery after it is fully charged

Each of these steps is described in detail below: (See **Figure 15** on page 17 for a photograph of the fully assembled Mower)

---

## **WARNING!**

**THE SAFETY KEY, WITH ITS BUILT-IN CIRCUIT BREAKER, AS WELL AS THE BATTERY, SHOULD NEVER BE INSERTED DURING ASSEMBLY, ADJUSTMENTS, CLEANING, BLADE REPLACEMENT, OR WHEN THE MOWER IS NOT IN USE. REMOVING THE SAFETY KEY WILL PREVENT ACCIDENTAL STARTING, AND HELP AVOID SERIOUS PERSONAL INJURY.**

---

### **Step 1: Read the *Safety & Operating Instructions* before proceeding.**

The NEUTON Mower is a motorized cutting machine that uses a sharp Blade. For your safety, and for best results, it is important to read the information in “Chapter 2: Important Safety Considerations” before you assemble or use the Mower.

To familiarize yourself with the assembly, features, and operation of your Mower, please read the remainder of this manual before proceeding.

**NOTE:** Do not discard the shipping box and packaging material until you are fully satisfied with your new NEUTON Battery-Powered Mower.

## Step 2: Adjust the Handlebar Height

**TIP**

To keep the Mower from moving while you adjust the Handlebar, place your foot behind one of the wheels.

1. Push down on the Handlebar Adjust Lever (**Figure 2**) and fold the Handlebar up to a comfortable position for you, and then release the Lever. You can choose any of four (4) positions.



Figure 2

## Step 3: Remove the Battery

You can quickly and easily remove the Battery from your Mower.

**TIP**

1. Push the Release Button back and open the Access Cover (**Figure 3**).

Push the Release Button back with one hand and open the Cover with the other.

2. Twist the Battery Retainer Arm either way until it is no longer blocking the Battery (**Figure 4**).

**TIP**

To help keep the Mower from rolling while removing the Battery, put one foot behind a wheel for stability.

3. Pull the Battery straight up and remove it.

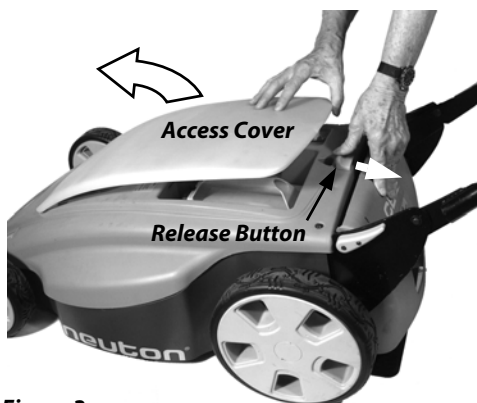

Figure 3

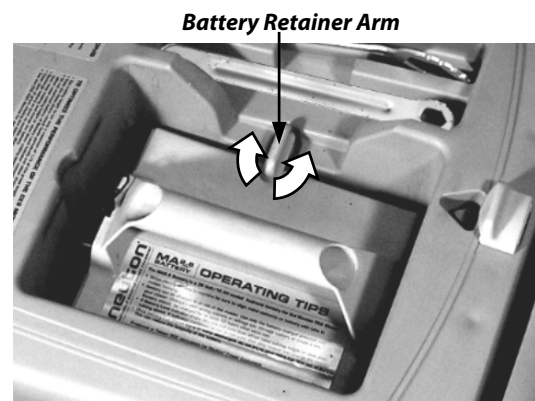

Figure 4

## Step 4: Charge the Battery before Your First Use

You **MUST** charge the Battery for ten (10) to twelve (12) hours maximum before you use the Mower for the first time. If you do not charge it before using the Mower, the Battery's charging capacity may decrease.

For instructions on removing and charging the Battery, read "Chapter 5: Charging and Caring for the Battery" before you operate the Mower.



## Step 5: Attach the Side Discharge Chute, Mulching Plug, or Rear Bagger

### Side Discharge Chute

The Side Discharge Chute (**Figure 5**) allows for proper discharge of the grass, which prevents clogging. The Chute is shipped without the Handle so you will have to install the Handle prior to use using a small Phillips Screwdriver. The Handle and Screw are located in the Product Pack bag that shipped with the Mower.

1. Raise the hinged Discharge Guard on the back of the Mower (**Figure 5**).
2. Orient the Discharge Chute as shown in **Figure 5**. Position the two (2) Hangers on the Chute over the Support Rod (**Figure 5**) and lower the Chute into place (**Figure 5**).
3. Lower the hinged Discharge Guard.

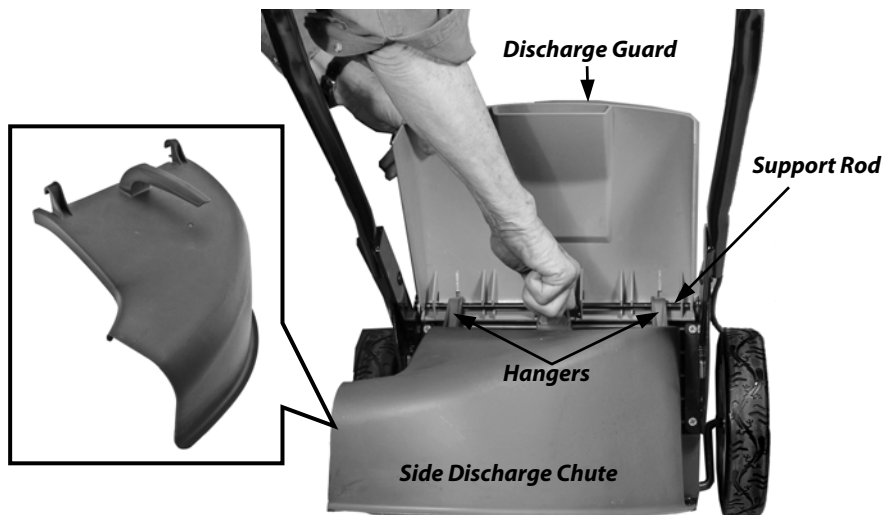

**Figure 5**

### Mulching Plug

To mulch your grass, install the Mulching Plug.

1. If necessary, remove the Rear Bagger or Side Discharge Chute from the Mower.
2. Install the Mulching Plug (**Figure 6**). Be sure to push the Plug all the way in until the Notch in its bottom is engaged.



There's a slight knack to installing the Plug; push the Plug in with a slightly arcing motion as follows:

- Align the Plug in the Mower.
- Start to push the top of the Plug in first.
- Then put pressure towards the bottom and slide in the Plug.

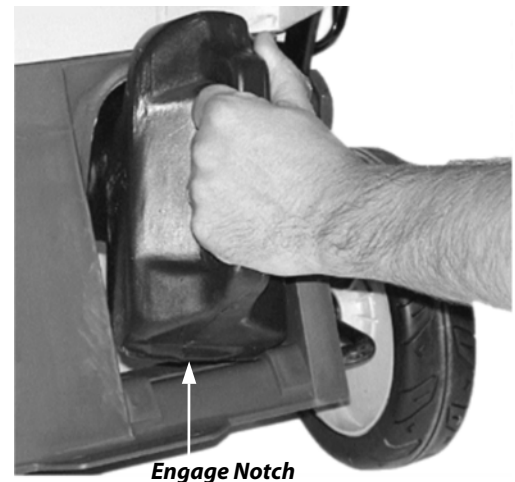

**Figure 6**



Figure 7

### **Rear Bagger**

The NEUTON Rear Bagger lets you cut and catch your grass clippings, eliminating the need to rake. The Rear Bagger easily attaches to the rear of the Mower (**Figure 7**). The Bagger is shipped unassembled. The following instructions outline the steps necessary to assemble, install, and remove the Bagger.

### **Assembling the Bag to the Bag Frame**

1. With the Bottom Stiffener Board facing down, insert the Frame into the Bag (**Figure 8**).
2. Snap the Bag Clips around the Frame top, sides and bottom (**Figures 9a – 9d**) to secure the Bag to the Frame.

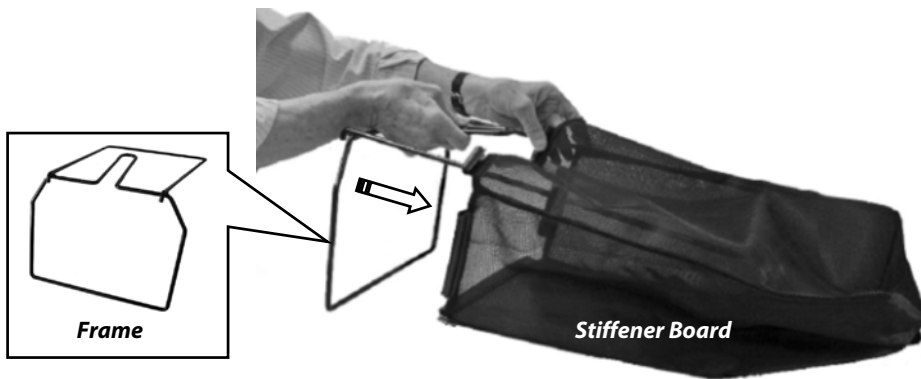

Figure 8



Figure 9a



Figure 9b



Figure 9c



Figure 9d

### Installing the Bagger

1. Raise the Discharge Guard on your Mower (**Figure 10**) and note the metal Support Rod at the rear of the Mower.
2. Grasp the Bagger by the Top Handle (**Figure 11**) and center it at the back of the Mower.
3. Align the Metal Latch Hooks (**Figure 11**) over the Support Rod (**Figure 12**) and lower the Bagger in place until the Wire Frame at the bottom of the Bagger rests on the Mower.
4. Lower the Discharge Guard.

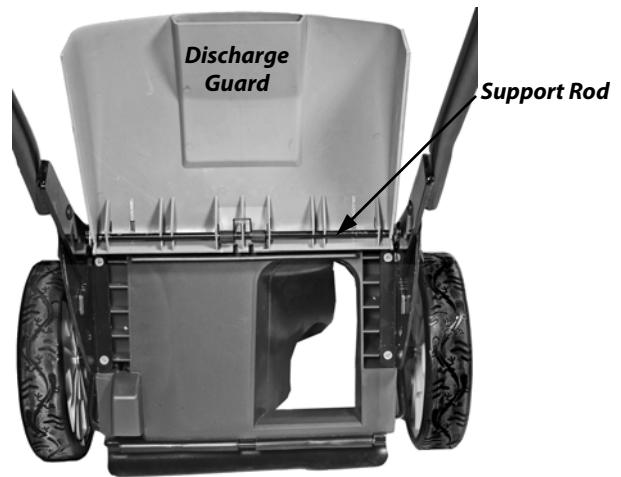

Figure 10

### Removing and Emptying the Bagger

1. Raise the Discharge Guard.
2. Using the Top Handle of the Bagger, lift the Bagger off the Support Rod and away from the Mower.
3. Lower the Discharge Guard.
4. To empty the Bagger, tilt the Top Handle forward. Use the Cloth Handle (**Figure 13**) at the rear of the Bagger to move the contents toward the front as you empty the Bagger.

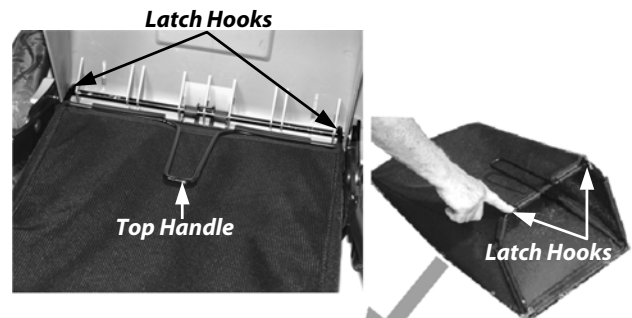

Figure 11

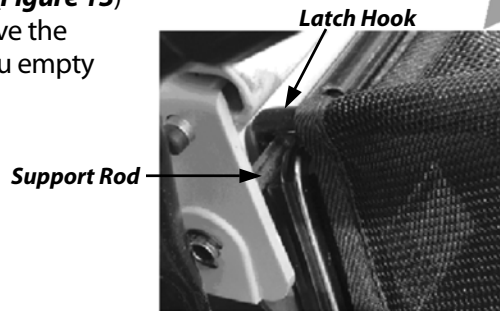

Figure 12

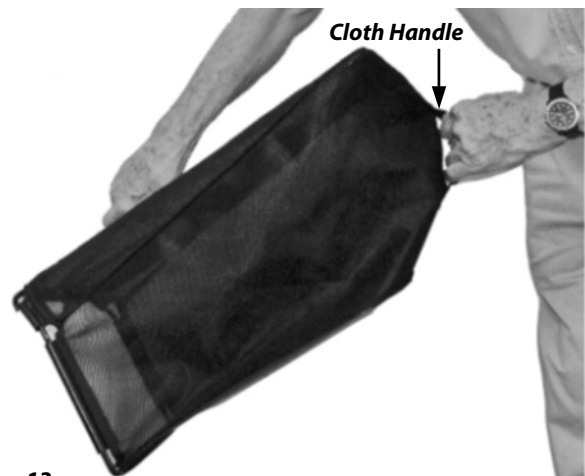

Figure 13

### Step 6: Insert the Battery after Being Fully Charged

1. Orient the Battery as shown in **Figure 14a**. Align the black side of the Battery with the side of the Mower housing where the label reads "Insert Battery with the black side along this edge."

**NOTE:** The indentations on the bottom of the Battery must line up with the metal tabs in the bottom the Battery compartment. A new replacement Battery now has a gold faceplate (originally black as seen in **Figures 14a and 14b** below).

2. After confirming the correct orientation of the Battery, insert the Battery fully into the Battery compartment.
3. Turn the Battery Retainer Arm back over on top of the Battery to secure it in place (**Figure 14b**).

## NOTICE

**IF THE BATTERY IS NOT ORIENTED CORRECTLY, IT WILL NOT FULLY DEPRESS INTO THE OPENING. IF THIS HAPPENS, REMOVE THE BATTERY, RECHECK THE ORIENTATION, AND TRY AGAIN.**

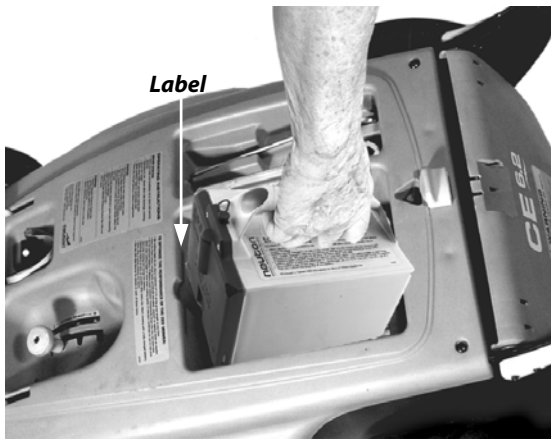

Figure 14a



Figure 14b

# Your Fully Assembled NEUTON Mower



Figure 15

# Controls and Features

Make certain that you are familiar with the Controls, Parts, and operation of your NEUTON CE6.2 Mower before using it.

## ⇒ Analog Voltage Gauge

The Analog Voltage Gauge indicates the amount of Battery life remaining. The yellow area indicates acceptable voltage whereas the red area indicates low voltage. You should raise the cutting height or mow slower if the gauge momentarily drops into the red area. Recharge the Battery if the gauge stays in the red area.

## ⇒ Safety Key

After you insert the Safety Key into the Safety Key Slot on the Mower, the Motor is now allowed to start and run. You can insert the Safety Key either way – it has no front or back. You should remove the Safety Key when not in use.

The Safety Key has a Built-In Circuit Breaker to protect the Motor.

**NOTE:** *If the Built-In Circuit Breaker trips, the white Button on top of the Safety Key will pop up. Before attempting to restart the Mower, push the white Button all the way down until it locks into place.*

## ⇒ Start Knob

The orange Start Knob is a safety feature that you must push across to the left before the Control Bar can be depressed.

## ⇒ Control Bar

The orange Control Bar is a safety feature. You must squeeze the Bar into the Handlebar for the Motor to start and run, and the Cutting Blade to spin. When the Control Bar is released, the Motor shuts off and the Blade stops spinning within three (3) seconds.

## ⇒ Power/Mode Switch

The Power/Mode Switch controls the power to the Mower, the Mower Blade, and the Optional Trimmer attachment. This Switch has three (3) settings.

- Mower (rear position), used for normal mowing; and
- Power OFF (center position), used to conserve Battery power; and
- Auxiliary (forward position), used when operating the Optional Trimmer attachment. For more information about options available for your NEUTON Mower, see “Chapter 6: Optional Attachments”.

### NOTICE

When the machine is not in use, you must make sure that the Power/Mode Switch is in the center, OFF position. If the Switch is not in the center, OFF position with the Battery installed in the Mower, it will deplete the Battery since the Green Status Indicator Light will be illuminated.

## ⇒ Status Indicator Light

The green Status Indicator Light on the Lower Crossbar (**Figure 16**) lights up when you install a charged Battery and insert the Safety Key.

**NOTE:** A green Status Indicator Light does not guarantee that the Battery is fully charged, only that it has some charge, the Safety Key has been inserted, the electrical system is ready, and that the Mower can be started.



Figure 16

## NOTICE

**IF THE GREEN STATUS INDICATOR LIGHT GOES OUT, DO NOT OPERATE THE MOWER AGAIN UNTIL THE BATTERY IS FULLY CHARGED. IF YOU DO OPERATE THE MOWER WITH THE GREEN STATUS INDICATOR LIGHT OUT, THIS WILL RESULT IN DECREASED CHARGING CAPACITY.**

**NOTE:** Although you may notice that a short period of rest may restore the Status Indicator Light, you still must fully charge the Battery before continuing to mow. For best results, be sure to always fully charge the Battery for ten (10) to twelve (12) hours maximum after every use.

## ⇒ Cutting Height Lever

The Cutting Height Lever (**Figure 17**), located under the Access Cover, allows you to easily adjust how high or low you cut the grass. Notice that there are four (4) different Height Positions.

**TIP** → To easily move the Cutting Height Lever, hold the Handlebar with your right hand to keep the Mower steady and adjust the Lever with your left hand.

To easily adjust this Lever, push the Lever out of its present notched position and move the Lever up or down to the desired level. When you reach the desired level, simply release the Lever into the notch.

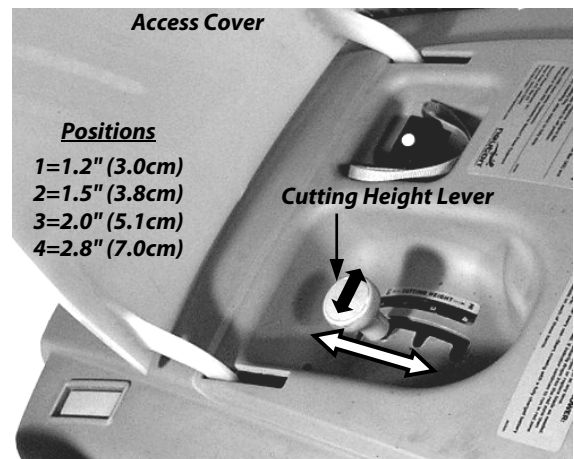

Figure 17

## ⇒ Power/Mode Switch

The Power/Mode Switch (**Figure 18**) controls the Mower, Power, and optional Trimmer. This Switch has three (3) settings.

- Mower (rear position), used for normal mowing; and
- Power OFF (center position), used to conserve Battery power (green Status Indicator Light goes out); and
- Auxiliary (forward position), used when operating the Optional Trimmer.

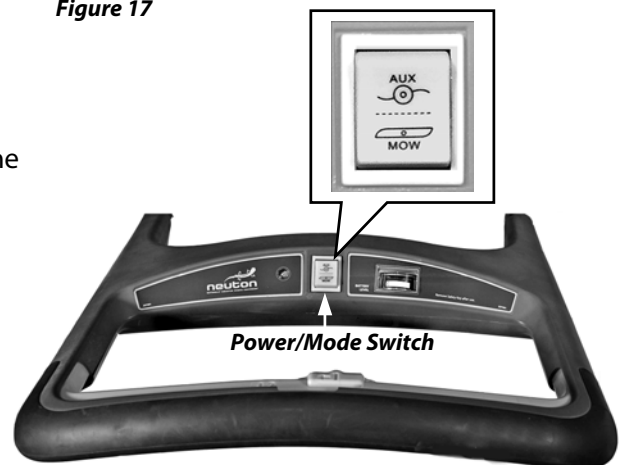

Figure 18

## ⇒ Analog Voltage Gauge

The Analog Voltage Gauge (**Figure 19**) indicates the amount of Battery life remaining. The yellow area indicates acceptable voltage whereas the red area indicates low voltage. You should raise the Cutting Height or mow slower if the gauge momentarily drops into the red area. Recharge the Battery if the gauge stays in the red area.

**NOTE:** *The Analog Voltage Gauge will only show the Battery's voltage when you correctly insert the Battery in the machine and the Power/Mode Switch is in either the Mow, or Auxiliary position.*



**Figure 19**



# Neuton CE6.2 Product Specifications

## Motor

---

RPM	3800
Tip Speed	18,000 ft./min.
AMP Idle	5 – 6
AMP Cutting	10 – 12
Size	750W, 36V DC/50 Amp
Noise	Under 80 Decibels

## Controls

---

Start/Stop	Safety Control Bar
Shape	Ergonomically Designed
Key	Removable Safety Key w/Circuit Breaker
Electric System	Electro-mechanical Relay

## Housing

---

Material	Injected Polypropylene
Handlebar Height Adjustment (at lowest housing height setting)	34.8" – 40.5"
Wheels, Front	7.25" x 2", Molded Rubber Tread
Wheels, Rear	10" x 2.1", Molded Rubber Tread
Weight	69 lbs. 10 oz. (including Battery) 46 lbs. 5 oz. (without Battery)
Housing Length	34.5"
Housing Width	21"
Housing Height	12.5"

## Cutting

---

Cutting Deck Width	19.11"
Blade	19" Aero Blade
Blade Nut Torque	16.6 ft-lbs.
Cutting Height	Adjustable from 1.2 – 2.8 inches
Discharge Chute	Included
Bagger	Included
Bagger Capacity	1.33 Bushel (1.65 cubic ft.)
Mulching Plug	Included
Trimming	Optional Attachment
Striper	Optional Attachment
Blade Sharpener	Optional Accessory

## Battery

---

Voltage	36V DC
AMP	10 Amp-Hour
Type	Sealed, Lead/Acid
Weight	23 lbs. 5 oz.
Approximate Run Time	45 - 60 minutes for fully charged Battery
Battery Charger	Included. 36V Charger, plugs into standard electrical outlet
Charge Time	10 – 12 Hours maximum

## Meets CPSC Mower Safety Standards

***NOTES:***

# Chapter 4: Operating Your NEUTON Mower

---

This chapter explains how to Start, Stop, and adjust the Cutting Height of your Mower.

**NOTE:** *If the Mower Battery is not fully charged or if you are unpacking a new Mower for the first time, read “Chapter 5: Charging and Caring for the Battery” before operating the Mower. You should charge the Battery for ten (10) to twelve (12) hours maximum before use.*

## Pre-Start Checks



**DO NOT INSERT THE SAFETY KEY UNTIL YOU HAVE COMPLETED ALL OF THE PRE-START CHECKS AND YOU HAVE MOVED THE MOWER TO THE AREA THAT YOU ARE GOING TO MOW.**

---

Perform the following checks each time before operating your Mower.

- Check under the Mower Deck and make sure that the Blade is attached securely. Inspect for any visible damage to the Blade or Deck, and remove any accumulation of dirt, dust, or dried grass clippings.
- Make sure all Knobs, Bolts, Attachments, Guards, and Covers are in place and securely attached.
- Attach the Side Discharge Chute, the Rear Bagger, or the Mulching Plug.
- Set the Mower to the desired Cutting Height. See “Adjusting the Cutting Height” on page 24 for details.
- Be sure the Battery is fully charged.
- Be sure to set the Power/Mode Switch to “Mowing” (the “Mowing” side of the switch, toward you, is pushed down).
- Push the Mower (before starting it) to the lawn area that you wish to mow.

**NOTE:** *The length of time that a Battery can hold a charge while mowing depends upon lawn conditions; tall or thick grass makes the Mower work harder causing the Battery to discharge faster.*

# Adjusting the Cutting Height

Using the Cutting Height Lever located under the Access Cover (**Figure 20**), adjust the Cutting Height so that you cut off only one (1) to two (2) inches of grass at a time.

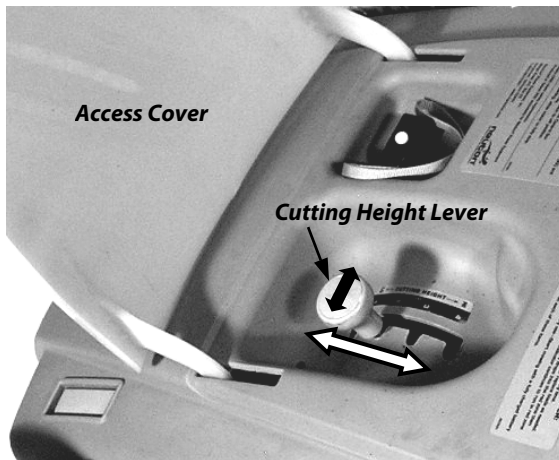

1. Open the Access Cover and remove the Safety Key.
2. Make sure all four (4) Wheels are level.
3. Push the Lever out of its present notched position and move the Lever up or down to the desired level. When you reach the desired level, simply release the Lever into the notch.



To easily move the Cutting Height Lever, hold the Handlebar with your right hand to keep the Mower steady and adjust the Lever with your left hand.

**Figure 20**

Each position adjusts the Mower's Blade level to a different Cutting Height. Pushing the Cutting Height Lever towards Position 1 cuts more grass (which leaves your grass shorter); pushing the Lever towards Position 4 cuts less grass (leaving your grass longer).

The following table lists the final cut grass heights.

Lever Position	Cut Height
1	1.2" (3.0 cm)
2	1.5" (3.8 cm)
3	2.0" (5.1 cm)
4	2.8" (7.0 cm)

## Mowing on Slopes

Slopes are a major factor related to slip-and-fall accidents, which can result in severe injury. All slopes require caution. If you feel uneasy on a slope, do not mow it.

*Always:*

- Use caution on slopes. Whenever possible, mow across the face of slopes, not up and down. Exercise caution when changing direction on slopes.
- Remove objects such as rocks and tree limbs, or any other potential object possibly thrown by the Mower Blade. Objects struck by the Mower Blade can cause severe injuries.
- Watch for holes, ruts, or bumps. Tall grass can hide obstacles.

*Never:*

- *Never* mow near drop-offs, ditches, or embankments. You could lose your footing or balance.
- *Never* mow steep slopes or any other areas where stability or traction is in doubt.
- *Never* mow on wet grass. Unsure footing could cause you to slip.

# Starting the Motor and Engaging the Blade

## NOTICE

- **STARTING, STOPPING, AND RESTARTING AN ELECTRIC MOTOR REPEATEDLY WITHIN A FEW SECONDS CAN GENERATE A GREAT DEAL OF HEAT AND DAMAGE THE MOTOR. TO PROTECT THE LIFE OF YOUR NEUTON MOWER, ALWAYS WAIT AT LEAST FIVE (5) SECONDS AFTER STOPPING BEFORE RESTARTING THE MOWER.**
- **THE CUTTING BLADE ALWAYS TURNS WHEN THE MOTOR IS RUNNING; THERE IS NO CLUTCH TO ALLOW THE BLADE TO STOP ROTATING WHILE THE MOTOR IS RUNNING.**

1. Perform the Pre-Start Checks listed previously.
2. Insert the Safety Key into the Key Slot (**Figure 21**). You can insert the Safety Key either way. The green Status Indicator Light on the Lower Crossbar should come on.

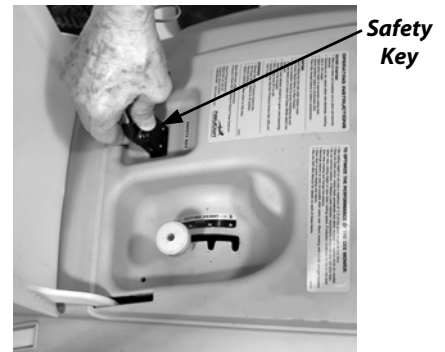

Figure 21

## Starting the Mower

1. Slide the orange Start Knob to your left (**Figure 22**).
2. Squeeze and hold the orange Control Bar (**Figure 23**). The orange Start Knob fits snugly into the Slot on top of the Handlebar.
3. Continue to hold the Control Bar against the Handlebar for as long as you want the Motor to run.



Figure 22



Figure 23

If the Mower does not start, first check for simple solutions:

- Make sure the Battery is in, the Safety Key is in, and the Status Indicator Light is green.
- Make sure the Power/Mode Switch is in the Mower position.
- Make sure the white Circuit Breaker Button on the Safety Key is depressed.
- Did you follow the two (2)-step Start sequence: slide the orange Start Knob to the left, then squeeze and hold the Control Bar?

**NOTE:** If the Mower still does not start, follow the steps in "Chapter 8: Troubleshooting Tips".

## **WARNING!**

**THE ORANGE CONTROL BAR IS A SAFETY DEVICE; DO NOT TAMPER WITH IT.**

# Stopping the Motor and Blade

Simply releasing the orange Control Bar stops the Motor and Blade.

---

## **WARNING!**

**THE BLADE CONTINUES TO ROTATE FOR A FEW SECONDS AFTER YOU SHUT OFF THE MOTOR.**

---

## When Finished Mowing

- Remove the Safety Key when the Mower is unattended.
- Return the Power/Mode Switch to the center, OFF position.
- Remember to recharge the Battery after each use; no matter how short a time you used it. See "Charging the Battery" on page 28 for details.

---

## **WARNING!**

**YOU SHOULD NEVER HAVE THE SAFETY KEY WITH ITS BUILT-IN CIRCUIT BREAKER AND THE BATTERY INSERTED DURING ADJUSTMENTS OR BLADE REPLACEMENT. REMOVING THE SAFETY KEY WILL PREVENT ACCIDENTAL STARTING, AND HELP AVOID SERIOUS PERSONAL INJURY.**

---

## Mowing and Lawn Care Tips

- For the best mowing results, mow at a steady pace. If you try to walk too quickly, especially in tall or thick grass, the quality of the cut may not be uniform. To avoid damage and extend Battery life, always mow at a pace allowing the Motor to run smoothly.
- The length of time that the Battery can hold a charge while mowing depends upon lawn conditions; tall, thick, or damp grass make the Mower work harder, causing the Battery to discharge faster. Under normal mowing conditions, the run time is between forty-five (45) and sixty (60) minutes. To mow longer, consider purchasing a second Battery and keep it fully charged.
- Before starting the Mower, adjust the Cutting Height so that you only cut one (1) to two (2) inches of grass at a time. Cut thicker grass at a higher Cutting Height, or cut a narrower swath. Do not force the Mower forward in thick grass; rather, cut it with a couple of passes. Your NEUTON Mower will do a better and safer job when cutting at a steady pace.
- Mowing dense grasses, such as St. Augustine or Bermuda grass, requires more power to cut properly. For these grasses, it may be necessary to move more slowly to ensure a quality cut.
- Mow as often as needed so that you are only cutting one (1) to two (2) inches of grass each mowing session. Trying to cut more than two (2) inches at a time will drastically reduce the charge life of the Battery and quality of the cut.
- For the healthiest lawn, avoid removing more than one third (1/3) of the leaf blade during any one (1) mowing session. When more than one third (1/3) of the leaf blade is removed, the grass plant produces less food for itself and therefore becomes weaker and more susceptible to disease and insect damage.
- Frequent stopping and restarting of the Mower will use additional Battery energy. Try to work continuously and smoothly when mowing.
- Keep your Mower Blade sharp. A sharp Blade cuts the grass quickly and cleanly, using less of the Mower's power, which conserves Battery life. For best results, inspect the Blade often and have an extra, sharp Blade ready to install as a replacement while you have the dull Blade sharpened.
- Mow across slopes; never up and down.

# Chapter 5: Charging and Caring for the Battery

---

## CAUTION!

**BEFORE CHARGING THE BATTERY, READ ALL INSTRUCTIONS AND CAUTIONARY MARKINGS IN THIS MANUAL AND ON YOUR MOWER. DO NOT OPERATE YOUR MOWER UNTIL YOU HAVE READ AND UNDERSTAND ALL INSTRUCTIONS AND THE BATTERY IS FULLY CHARGED.**

---

## The Battery

The NEUTON Mower comes with a sealed, lead acid Battery already installed at the factory. The Battery is 36 volts and rated at 10 amp-hours. The Battery should not leak, regardless of the position in which it is stored. Read "Handling the Battery Safely" in Chapter 2 for additional information.

The Battery is completely maintenance free. You never need to add water. However, as with all rechargeable Batteries, after years of use they will eventually need replacement. With proper care, this Battery may last three (3) to five (5) years. Please refer to "Chapter 7: Maintaining and Storing Your NEUTON Mower" for more information.

---

## WARNING!

- **DO NOT STORE, OR CHARGE THE BATTERY NEAR CHILDREN, PETS OR CLOSE TO A SOURCE OF HEAT, SPARKS, OPEN FLAME, OR ON THE FLOOR AS IT MAY BE DAMP OR SUBJECT TO ACCIDENTAL FLOODING. IN ADDITION, NEVER EXPOSE THE BATTERY TO ABNORMAL SHAKING OR SHOCKS.**
  - **CHARGE THE BATTERY IN A WELL VENTILATED AREA.**
  - **REGULARLY INSPECT THE EXTERNAL APPEARANCE OF THE BATTERY AND NEVER USE, OR CHARGE A BATTERY THAT SHOWS CRACKS, CHANGES IN SHAPE, LEAKS, OR IS OBVIOUSLY DAMAGED. IF THE BATTERY BECOMES HOT TO THE TOUCH DURING CHARGING, THIS MAY ALSO BE A SIGN OF A DAMAGED BATTERY.**
  - **NEVER ATTEMPT TO ALTER OR OPEN THE BATTERY, AS THIS WILL VOID YOUR BATTERIES WARRANTY. USE NORMAL HOUSEHOLD VOLTAGE (110 VOLTS) WHEN CHARGING THE BATTERY. PLUG THE CHARGER DIRECTLY INTO THE ELECTRICAL OUTLET.**
  - **REGULARLY INSPECT THE CHARGER RECEPTACLE OF THE BATTERY AND NEVER USE, OR CHARGE A BATTERY THAT HAS VISIBLE DAMAGE OR DEBRIS WITHIN THE CHARGER RECEPTACLE. IF THERE IS DEBRIS PRESENT, PLEASE USE CAUTION TO REMOVE THE DEBRIS. DO NOT REMOVE THE DEBRIS WITH ANY METALLIC OBJECTS, DAMP OR FLAMMABLE ITEMS, OR ITEMS THAT MAY BECOME LODGED IN THE CHARGER RECEPTACLE AS THIS MAY CAUSE A FIRE, OR EXPLOSION OF THE BATTERY. IF YOU OBSERVE DAMAGE TO THE CHARGER RECEPTACLE, PLEASE DISCONTINUE USE IMMEDIATELY.**
  - **RISK OF ELECTRIC SHOCK; DO NOT TOUCH THE NON-INSULATED PORTION OF THE OUTPUT CONNECTOR OR THE NON-INSULATED BATTERY TERMINAL.**
  - **USE THE NEUTON 36-VOLT CHARGER ONLY WITH THE NEUTON 36-VOLT BATTERY. USE OF OTHER CHARGERS OR THE NEUTON 36-VOLT CHARGER WITH OTHER TYPES OF BATTERIES MAY RESULT IN BURSTING OF THE BATTERY, WHICH COULD CAUSE PERSONAL INJURY AND PROPERTY DAMAGE.**
- 

## TIPS

- Under normal conditions, the Battery charge should last for approximately forty-five (45) to sixty (60) minutes per use. The length of time depends on the length, density, and dampness of the grass. If you generally intend to use your Mower and Trimmer for a longer duration, Neuton Power Equipment recommends that you purchase an extra Battery. That way, you could have a second fully charged Battery ready so you can continue mowing.
- It may take up to five (5) charging and discharging cycles before your Battery provides maximum life.
- A Battery may last much longer if you charge it as soon as it starts to lose power and not let it completely discharge. You should not try to coax a little more power out of your Battery.

## Charging the Battery

---

### NOTICE

PERIODICALLY INSPECT THE CORDS ON THE CHARGER UNIT AND THE HANDLEBAR FOR DAMAGE. IF DAMAGE OCCURS, DO NOT USE THE MOWER UNTIL THE CORDS HAVE BEEN REPLACED OR REPAIRED. IF DAMAGE TO THE CHARGER OCCURS, DISCONTINUE USE OF THE CHARGER IMMEDIATELY AND VISIT OUR WEBSITE AT [WWW.NEUTONPOWER.COM](http://WWW.NEUTONPOWER.COM) OR CALL NEUTON POWER EQUIPMENT TOLL FREE AT: 1-866-NEUTON1 (638-8661) FOR A REPLACEMENT CHARGER. DO NOT ABUSE THE CORD. NEVER CARRY THE CHARGER BY THE CORD. ALWAYS PULL THE CHARGER – AND NOT THE CORD – WHEN DISCONNECTING THE CHARGER FROM THE ELECTRICAL OUTLET (WALL OUTLET). ALWAYS PULL THE CHARGER CONNECTOR – AND NOT THE CORD – WHEN DISCONNECTING THE CHARGER FROM THE CHARGING RECEPTACLE ON THE BATTERY AFTER CHARGING. WHEN USING AN EXTENSION CORD WITH YOUR CHARGER, USE A HEAVY-DUTY EXTENSION CORD OF A TYPE “SUITABLE FOR OUTDOOR USE” (ALTHOUGH YOU SHOULD NEVER CHARGE THE BATTERY IN THE OPEN OUTDOORS).

---

---

### NOTICE

WHILE THE BATTERY IN YOUR MOWER WAS CHARGED AT THE FACTORY, YOU MUST RECHARGE IT FULLY TEN (10) TO TWELVE (12) HOURS MAXIMUM BEFORE USING YOUR MOWER. OTHERWISE, YOU MAY DECREASE THE CHARGING CAPACITY OF THE BATTERY. AGAIN, USE ONLY THE CHARGER SUPPLIED WITH THE MOWER.

---

---

### WARNING!

USE NORMAL HOUSEHOLD VOLTAGE (110 VOLTS) WHEN CHARGING THE BATTERY. PLUG THE CHARGER DIRECTLY INTO THE ELECTRICAL OUTLET. DO NOT ABUSE THE CORDS. NEVER CARRY THE CHARGER BY THE CORD. ALWAYS PULL THE PLUG – AND NOT THE CORD – WHEN DISCONNECTING THE CHARGER FROM THE ELECTRICAL OUTLET (WALL OUTLET).

---

*NOTE: When using an extension cord with your Charger, use a heavy-duty extension cord of a type “suitable for outdoor use” (although you should never charge the Battery in the open outdoors).*

---

---

### NOTICE

ALWAYS CONNECT THE CHARGER TO THE BATTERY FIRST, AND THEN PLUG THE CHARGER INTO THE WALL OUTLET. WHEN UNPLUGGING, REVERSE THE PROCESS; UNPLUG THE CHARGER FROM THE WALL OUTLET FIRST, AND DISCONNECT IT FROM THE BATTERY. THE OPTIMAL AMBIENT TEMPERATURE FOR CHARGING OF THE BATTERY IS BETWEEN +32°F (0°C) AND +104°F (+40°C) AND THE OPTIMAL AMBIENT TEMPERATURE FOR STORAGE OF THE BATTERY IS BETWEEN +5°F (-15°C) AND +104°F (+40°C).

---

You must charge the Battery before using your Mower for the first time and after every use. Always charge the Battery out of the Mower.



## Charging with the Battery out of the Mower

1. Remove the Battery from the Mower.
2. Remove the Protective Plug from the Charger Receptacle on the Battery and plug in the round Charger Connector (**Figure 24**).
3. Plug the Charger into a standard 110-Volt wall outlet. The RED light on the Battery will illuminate indicating a connection between the Battery and the Charger. The LED light on the Charger will quickly change from GREEN to RED indicating that the Battery is charging.
4. After ten (10) to twelve (12) hours, the Battery should be completely recharged. The LED on the Battery will not turn OFF or change colors.

**NOTE:** The LED on the Charger may not have changed to GREEN and may still be RED after twelve (12) hours of charging. This does not mean that the battery is not completely charged. Do not charge any longer than 12 hours.

5. Remove the charger from the battery and from your standard 110-Volt wall outlet and place both the Battery and the Charger in a **DRY** environment for storage until you need them again.

**NOTE:** For the first five (5) hours, the Charger may be warm to the touch. This is normal and does not indicate a problem.



Figure 24

---

### NOTICE

**ALWAYS KEEP THE BATTERY IN A DRY PLACE.**

---

## Disconnecting the Charger

Remember to disconnect the Battery from the Charger using this sequence:

1. Pull the plug from the Charger out of the wall outlet.
2. Disconnect the Charger from the Battery and replace the Protective Plug.

---

### WARNING!

**ALWAYS DISCONNECT THE CHARGER FROM THE ELECTRICAL (WALL) OUTLET FIRST, AND THEN DISCONNECT THE ROUND CHARGER PLUG FROM THE BATTERY. IF YOU REMOVE THE ROUND CHARGER PLUG FIRST, THE EXPOSED CONNECTOR COULD BE ACCIDENTALLY SHORT-CIRCUITED BY FOREIGN MATERIAL, WHICH MIGHT CAUSE A FIRE.**

---

## **Recharging after each use of the Mower**

Always fully recharge the Battery immediately after each use; no matter how short a time you used it. Fully recharge even if the Analog Voltage Gauge on the Mower is in the yellow or green area. This is important in order to maintain maximum Mower performance and extend the useful life of the Battery. If you are using the Mower and the Analog Voltage Gauge needle moves into the Red section, suggesting low Battery charge, then you should stop using the Mower and either replace or recharge the Battery.

Unlike “Smart Batteries” found in devices such as cell phones, you should NOT run the NEUTON Mower Battery until completely drained. You will reduce the long-term performance of the Battery if allowed to run to full depletion.

# Recharging to Full Charge for Off-Season Storage

---

## NOTICE

**IF A DEPLETED BATTERY IS STORED, THE CHARGING CAPACITY OF THE BATTERY WILL DECREASE AND WILL SUBSEQUENTLY CAUSE PERMANENT DAMAGE TO THE BATTERY. YOU MUST RECHARGE THE BATTERY PRIOR TO STORAGE.**

---

At the end of your mowing season, remove the Battery from the machine and follow the charging procedures as outlined above. Once charging is complete, remove the Charger from the Battery and from your standard 110-Volt wall outlet. Store the Battery in a **DRY** environment with temperatures between +5°F (-15°C) and +104°F (+40°C) unplugged from the Charger and separate from the Mower. Every one (1) to two (2) months thereafter and just prior to the first mowing of the season, you should completely charge the Battery again for optimal performance and life.

For Off-Season storage of the Battery, it is important that the Battery is fully charged. Consider these facts when choosing your method of storing the Battery:

- Leaving the Battery with a full charge is the best way to store the Battery.
- Over time, Batteries will slowly discharge.

For more information on storing your Mower, see “Chapter 7: Maintaining and Storing your NEUTON Mower”.

# Caring for the Battery

You can lengthen the life of your Battery by following some simple guidelines.

- Always charge the Battery inside in a garage or other covered area where it will be dry and protected from the weather.
- Only charge the Battery when the temperature is at least 32°F (0°C) – above freezing – but not more than 104°F (40°C). Charging in lower or higher temperatures can be harmful to the Battery.
- Always keep the Battery away from water, heat sources (stoves, radiators, open flame, etc.), and hazardous chemicals.
- Use only an approved 36-Volt NEUTON Charger to charge the Battery. Make sure that the NEUTON Charger output voltage printed on the Charger label matches the voltage of your Battery. Use of a different Charger may not allow the Battery to fully recharge and may cause a fire or explosion. Use of a non-approved NEUTON Charger will void your warranty.
- Never use the Charger on any other product. Never operate a damaged Charger. If there is damage to a cord or the Charger Unit, replace the Charger or have it repaired.
- When storing the Battery after removing it from the Mower, follow the storage guidelines in “Chapter 7: Maintaining and Storing Your NEUTON Mower”.
- For long-term storage, please see “Recharging to Full Charge for Off-Season Storage” on page 30.
- If the Motor will not run after you have fully charged the Battery, consult the techniques in “Chapter 8: Troubleshooting Tips”. If you still need help, visit our website at [www.neutonpower.com](http://www.neutonpower.com) or call Toll Free **1-866-NEUTON1 (638-8661)** and one of our Technical Support Representatives will be happy to assist you.

## Recycling your Used Battery

### **WARNING!**

**NEVER ATTEMPT TO DISPOSE OF YOUR BATTERY IN A FIRE. THE CELLS MAY EXPLODE.**

### **NOTICE**

**PLEASE DISPOSE OF USED BATTERIES RESPONSIBLY, ACCORDING TO YOUR LOCAL HAZARDOUS MATERIALS REGULATIONS. NEVER THROW AWAY USED BATTERIES IN YOUR HOUSEHOLD TRASH.**

Please dispose of your used Batteries responsibly by recycling them. Call your local Solid Waste Management District or your local waste handler to locate the collection site nearest you. Some collection sites recycle Batteries year-round; others collect them periodically.

We have partnered with East Penn Manufacturing, one of the leading producers of lead-acid batteries in the U.S., to recycle your Battery when it reaches the end of its life. East Penn has nearly 100 distribution centers throughout the U.S. and Canada that will accept your Battery for recycling. East Penn will separate and reuse everything in your old Battery: the plastic cover, the lead, and even the Battery acid using a patented process. To find the location of the East Penn distribution center nearest you, visit <http://www.dekabatteries.com>. You can also visit the Web site of Earth 911 for more information [[www.earth911.org](http://www.earth911.org)]. Once there, click the Household tab at the top of the page and then enter your zip code. The site lists recycling centers located near you. You can also visit our website [www.neutonpower.com](http://www.neutonpower.com) and click on “Customer Service” to find distribution centers across the country that will accept your Battery for 100% recycling of the plastic, lead, and acid.

For a fee, you can recycle your Batteries with the International Metals Reclamation Company. Visit them at [www.inmetco.com](http://www.inmetco.com) and click Services; or contact them at:

INMETCO, P.O. Box 720, 245 Portersville Road, Ellwood City, PA 16117, (724) 758-2825; fax (724) 758-2845

To learn more about hazardous waste recycling, visit the Web site for Battery Council International [[www.batterycouncil.org](http://www.batterycouncil.org)] or for the Environmental Protection Agency [[www.epa.gov](http://www.epa.gov)].

## Chapter 6: Optional Attachments

You can purchase Optional Attachments for your NEUTON Mower. To order any of these Optional Attachments, please visit our website at [www.neutonpower.com](http://www.neutonpower.com) or call Neuton Power Equipment Toll Free 1-866-NEUTON1 (638-8661).

Your NEUTON Mower shipped with the Side Discharge Chute, allowing you to discharge grass clippings as the standard mowing mode, a rear Bagger which allows you collect grass clippings, and a Mulching Plug that allows you to mulch clippings.

### NEUTON Trimmer

The NEUTON Trimmer is a unique attachment that, when used with your NEUTON Mower (**Figure 25**), enables you to trim and edge your lawn and yard without having to buy a separate trimmer and edger – it's like having three (3) machines in one (1). The Trimmer simply plugs into the front of your Mower.

The description and operation of the Trimmer is in Chapter 9 of this manual.

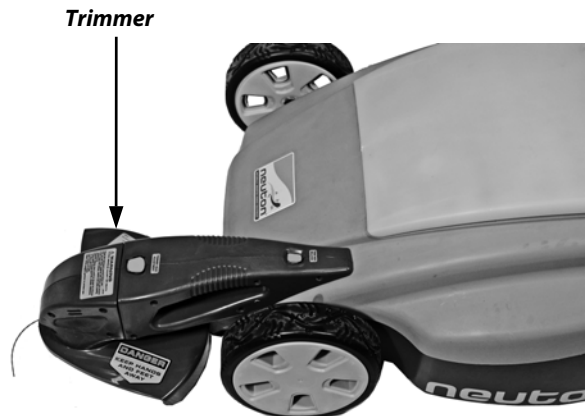

Figure 25

### Striper Roller

The Striper Roller (**Figure 26**) allows you to stripe your lawn (roll patterns) to give your lawn that professional manicured look of a golf fairway or baseball diamond! See Chapter 9, page 50, for information on connecting the Striper Roller.

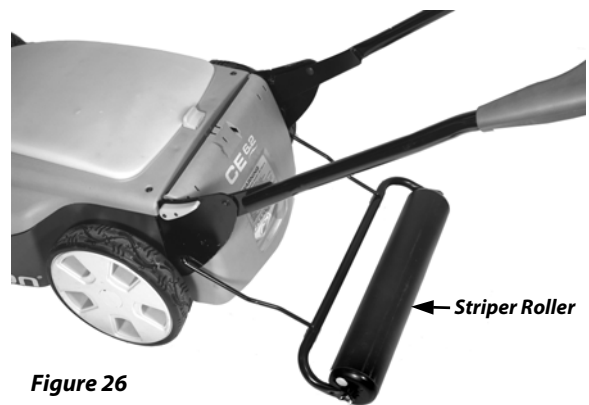

Figure 26

### Spare Battery

Owning a Spare Battery can be a wonderful time saver. A spare Battery allows you to quickly insert a fully charged Battery when the one you are using to mow loses its charge. Make sure you follow the charging and storage instructions as recommended in "Chapter 5: Charging and Caring for the Battery".

### Spare Aero Cutting Blade

Owning a Spare Aero Cutting Blade can make mowing more efficient. With the purchase of a replacement Blade (a new Blade Nut is included), when the existing Blade becomes dull, install the new spare Blade and then sharpen the dull Blade when you have the time. See "Sharpening the Blade" in Chapter 7 for more information.

# Blade Sharpener

The NEUTON Blade Sharpener (**Figure 27**) is a very useful hand-held sharpener.

1. Remove the Blade and secure it in a vise.
2. Position the carbide insert of the Sharpener, which has a “-” sign, against the edge to be sharpened.
3. Press down firmly and pull the Sharpener from the inside edge toward you. Usually three (3) or four (4) strokes are sufficient. Repeat for the opposite end of the Blade. It’s as simple as that!

**TIP** → You can also use the Blade Sharpener to easily sharpen Pruners, Loppers, Axes, or any other cutting or chopping tool.

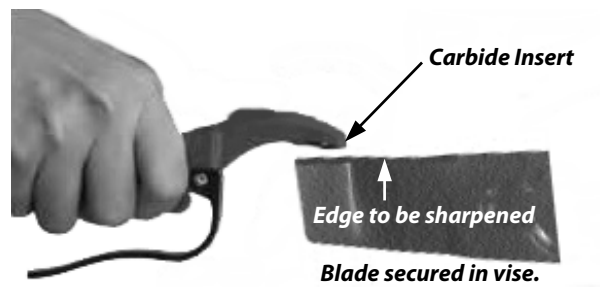

**Figure 27**

# Chapter 7: Servicing and Storing Your NEUTON Mower

---

This chapter explains how to clean your Mower; change, sharpen, and balance the Blade; and store your Mower for long term.

## Servicing Your Mower

---

### **WARNING!**

- NEVER MAKE ADJUSTMENTS OR REPAIRS WITH THE MOTOR RUNNING. ALWAYS STOP THE MOTOR, WAIT FOR THE BLADE TO STOP MOVING, REMOVE THE SAFETY KEY AND REMOVE THE BATTERY TO PREVENT ACCIDENTAL STARTING.
  - NEVER TAMPER WITH SAFETY DEVICES. CHECK THEIR PROPER OPERATION REGULARLY.
  - NEVER ATTEMPT TO MAKE WHEEL-HEIGHT ADJUSTMENTS WHILE THE MOTOR IS RUNNING.
  - GRASS CATCHER COMPONENTS ARE SUBJECT TO WEAR, DAMAGE, AND DETERIORATION, WHICH COULD EXPOSE MOVING PARTS OR ALLOW OBJECTS TO BE THROWN. CHECK COMPONENTS FREQUENTLY, AND REPLACE THEM WITH THE MANUFACTURERS RECOMMENDED PARTS WHEN NECESSARY.
  - CHECK THE BLADE AND MOTOR MOUNTING BOLTS AT FREQUENT INTERVALS FOR PROPER TIGHTNESS. USE ONLY AUTHORIZED NEUTON REPLACEMENT PARTS.
- 

---

### **CAUTION!**

- KEEP YOUR MOWER FREE OF GRASS, LEAVES, OR OTHER DEBRIS BUILD-UP.
  - ALLOW THE MOWER TO COOL FOR AT LEAST FIVE (5) MINUTES BEFORE SERVICING OR STORING.
  - THE MOWER BLADE IS SHARP, IT CAN AND WILL CUT. WRAP THE BLADE OR WEAR GLOVES, AND USE EXTRA CAUTION WHEN WORKING ON IT.
-

# Cleaning Your Mower

Periodically clean your Mower to ensure peak performance.

---

## **WARNING!**

**BEFORE PERFORMING THE FOLLOWING CLEANING PROCEDURES, REMOVE THE SAFETY KEY AND BATTERY TO PREVENT ACCIDENTAL STARTING.**

---

### **Supplies Needed:**

- Clean, damp cloth or sponge
  - Mild soap or detergent (if needed)
  - Soft nylon brush (if needed)
1. Using a damp cloth or sponge with a mild soap or detergent, clean the Mower. Never use water, gasoline, solvents, or other petroleum-based or solvent-based products when cleaning – remember that this is an electric Mower.
  2. Use a soft nylon brush or non-metallic scrubbing pad to remove any clippings that have accumulated on the underside of the Deck and in the Side Discharge Chute. Do not use a wire brush; it will scratch and harm the surface of your Mower.
  3. You may use water to clean the Rear Bagger when not attached to the Mower. For proper grass collection, make sure the Bagger is clean and the mesh holes are unclogged. Allow the Rear Bagger to dry thoroughly before using it again.

**NOTE:** *A wet Rear Bagger will clog quickly and hamper grass collection.*

## Cleaning the Handlebar

Remember to clean and lubricate the Handlebar on your Mower at least once a year or whenever grime builds up on the sliding parts of the Handlebar.

---

## **WARNING!**

**BEFORE PERFORMING THE FOLLOWING CLEANING PROCEDURES, REMOVE THE SAFETY KEY AND BATTERY TO PREVENT ACCIDENTAL STARTING.**

---

### **Supplies Needed:**

- Clean cloth or paper towel
- WD-40® or similar lubricant



## NOTICE

- USE ONLY LUBRICANTS THAT ARE COMPATIBLE WITH ELECTRICAL COMPONENTS SUCH AS WD-40®.
- NEVER USE SILICONE OR GRAPHITE BASED LUBRICANTS.

1. Spray a small amount of WD-40® or similar lubricant on a paper towel or clean cloth.
2. Clean both sides all along the top and sides of the orange Control Bar (**Figure 15** on page 17).
3. Slide the Start Knob (**Figure 22** on page 25) to the left and squeeze the orange Control Bar up into the top of the Handlebar as if you were starting the Mower (**Figure 23** on page 25).
4. Holding the orange Control Bar in this position, clean the inside side walls of the Handlebar where the orange Control Bar slides up and down.
5. Operate the orange Control Bar several times to insure that it is moving freely and properly returns to the OFF (down) position.

## WARNING!

IF YOU HAVE QUESTIONS OR IF THE ORANGE CONTROL BAR DOES NOT MOVE DOWN EASILY TO SHUT OFF THE MOWER IMMEDIATELY WHEN YOU RELEASE IT, DO NOT OPERATE THE MOWER. VISIT OUR WEBSITE AT [WWW.NEUTONPOWER.COM](http://WWW.NEUTONPOWER.COM) OR CALL US TOLL FREE: 1-866-NEUTON1 (638-8661). ONE OF OUR TECHNICAL SUPPORT REPRESENTATIVES WILL BE HAPPY TO HELP YOU.

## Removing and Attaching the Blade

### NOTICE

- YOU MUST REMOVE THE BLADE TO SHARPEN IT.
- ALWAYS CHECK THE BLADE FOR SHARPNESS, DAMAGE, AND TIGHTNESS BEFORE AND AFTER EACH USE. REPLACE THE BLADE PROMPTLY IF IT IS BENT OR DAMAGED.
- REPLACE THE BLADE WHEN WORN OR DAMAGED, BUT DO NOT USE IT FOR OVER FIVE (5) YEARS.

#### Tools and Supplies Needed:

- 36mm Wrench (supplied with Mower under the Access Cover)
- 3/4" Wrench (supplied with Mower under the Access Cover)
- Torque Wrench
- Heavy Gloves

## CAUTION!

WEAR HEAVY GLOVES TO PROTECT YOUR HANDS WHEN REMOVING AND ATTACHING THE BLADE.

1. Remove the Safety Key and the Battery. If you are charging the Battery in the Mower, first disconnect the Charger from the electrical (wall) outlet.
2. While holding the Handlebar (as if you were mowing) turn the Mower over on its right side to expose the Blade.
3. Place the 36mm Wrench over the Steel Hex Adapter (the large metal piece that holds the Blade in position) and place a 3/4" Socket or Wrench over the Blade Nut (**Figure 28**).
4. While holding the Hex Adapter in place, loosen the Blade Nut by turning counterclockwise. Be careful, hold the Hex Adapter firmly in place so that the Blade does not spin and strike your hand.

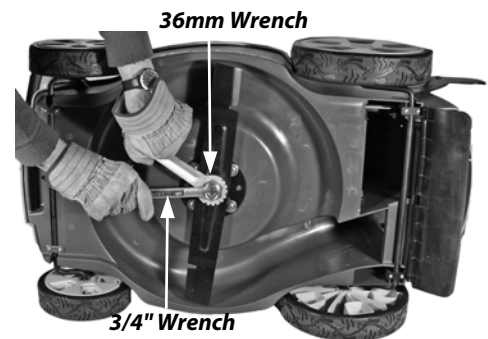

**Figure 28**



Hold the Wrenches at a slight angle to each other and squeeze together to avoid spinning the Blade. Squeeze the 3/4" Wrench clockwise to tighten the Nut and counterclockwise to loosen the Nut.

5. Remove the Blade Nut, Steel Hex Adapter, Blade, and Steel Blade Adapter in that order (**Figure 29**).
6. To install a sharpened Blade or a new Blade, reverse the order of step 5. Be sure to replace all parts exactly as you removed them (**Figure 29**) and make sure to properly seat the Blade.

**NOTE:** Be sure that the stamping on the Blade "THIS SIDE TOWARDS MOWER" is facing the Mower. Also, if replacing the Blade with a new one, use the new Nut supplied. If you assemble the Blade more than ten (10) times, replace the Blade Nut with a new one.

7. Place the 36mm Wrench over the Steel Hex Adapter, then place a Torque Wrench with a 3/4" Socket over the Blade Nut (**Figure 28**) and while holding the Hex Adapter in place, tighten the Blade Nut by turning clockwise to 16.6 Ft-Lbs. Again, be careful, hold the Hex Adapter firmly in place so that the Blade does not spin and strike your hand.
8. Make sure the Blade is firmly attached, and then turn your Mower upright.

## Sharpening the Blade

When the Blade is dull, the cut ends of the grass end up ragged and may turn brown soon after mowing. A dull blade also causes the Battery to discharge faster. When this occurs, sharpen the Blade (assuming the Blade is otherwise in good condition).

### Tools and Supplies Needed:

- (See list on previous page)
- Fine-Toothed File or NEUTON Blade Sharpener (optional)
- Safety Glasses
- Vise

1. Remove the Blade (see steps 1 thru 5 above).
2. Secure the Blade in a sturdy Vise and while wearing Safety Glasses, carefully file the Cutting Edges of the Blade using even strokes. Be sure to file both sides and both ends equally.



Simply counting the number of strokes per edge will help to keep the sharpening equal.

3. Check the blade after sharpening to be sure it is still balanced (see next page).

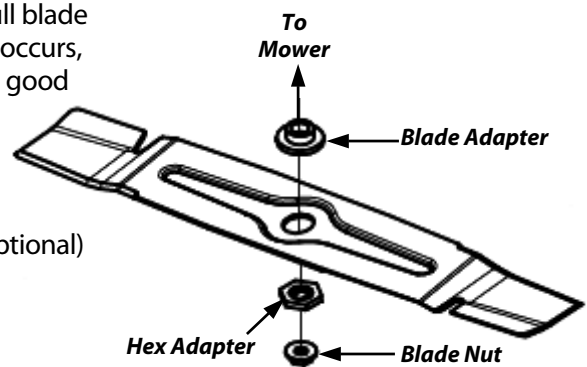

**Figure 29**

## Balancing the Blade

An out-of-balance Blade causes your machine to vibrate excessively. Excessive vibration may cause damage to the Mower, especially the Motor.

Because you are removing metal from the Blade, make sure to remove an equal amount from each end to keep the Blade balanced. The best way to balance a Blade is with a Blade Balancer (available at most local Hardware stores); or with a large Screwdriver, Nail, or Bolt.

### Tools and Supplies Needed:

- Gloves
- Blade Balancer, or a large Screwdriver, Nail, or Bolt

1. After sharpening the Blade, hang it on the Balancer and check the level (**Figure 30**). If one side of the Blade tips lower than the other side, sharpen the lower end a little at a time until the Blade is level (balanced).

**NOTE:** When sharpening a used Blade, be especially careful to keep it balanced. If in doubt, replace the Blade with a new one. Of course, you can always have a Mower Service sharpen and balance your Blade.

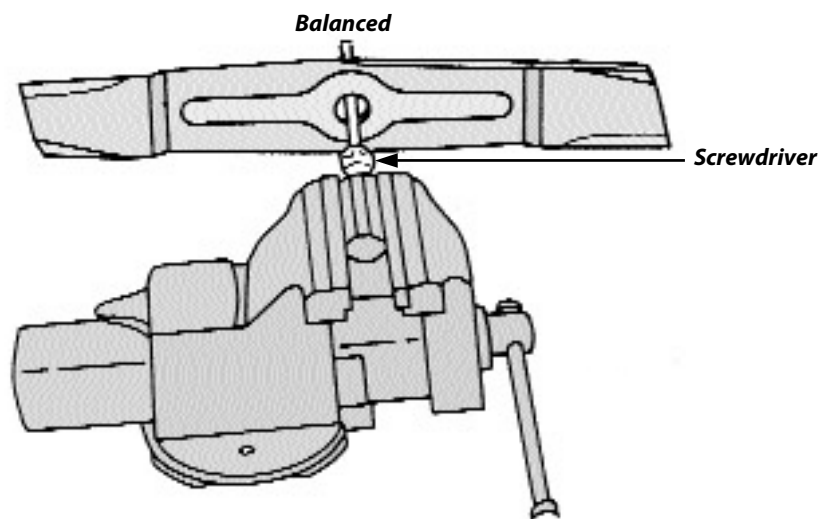

**Figure 30**

# Storing Your NEUTON Mower

## **WARNING!**

**ALWAYS STOP THE MOTOR, WAIT FOR THE BLADE TO STOP MOVING, REMOVE THE SAFETY KEY AND REMOVE THE BATTERY TO PREVENT ACCIDENTAL STARTING DURING STORAGE.**

Whether you store the Mower for a short or long period, always remember these important guidelines:

- Always store the Mower with a full Battery charge and follow the recharging instructions in “Chapter 5: Charging and Caring for the Battery”.
- Always store the Mower in an environment where the temperature is between +5°F (-15°C) and +104°F (+40°C). Make sure the storage temperature will never be outside these limits.
- Store the Mower in a dry environment. Water will damage the Mower and Battery.
- Do not store the Mower near chemicals, such as fertilizers. These products are often highly corrosive and may cause permanent damage to your Mower.
- Do not store the Battery in proximity to organic or other solvents.
- Always keep the Safety Key in a safe place away from children, separate of the Mower.

If you must store the Battery outside the Mower, follow these rules:

- If you will use the Battery again, give it a full charge.
- Do not store the Battery close to a source of heat, sparks, or open flame.
- The surrounding temperature range must be between +5°F (-15°C) and +104°F (+40°C).
- Do not expose the Battery to abnormal shaking or shocks.
- Store the Battery away from children and animals.
- Store the Battery in as **DRY** an environment as possible. Do not store it on a floor that may be damp or subject to accidental flooding.
- Regularly observe the external appearance of the Battery and keep it clean and dry. Never use a Battery that shows cracks, changes shape, leaks, or obviously damaged.
- During long-term storage of Batteries that are intended for reuse, periodically recharge the Battery, as recommended in “Chapter 5: Charging and Caring for the Battery”.

# Chapter 8: Troubleshooting Tips

Most difficulties are easy to fix. Consult the Troubleshooting Table for common problems and their solutions. If you continue to experience problems or need repairs beyond these minor adjustments, visit our website at [www.neutonpower.com](http://www.neutonpower.com) or call Neuton Power Equipment Toll Free at: **1-866-NEUTON1 (638-8661)** for assistance.

## **WARNING!**

**ALWAYS REMOVE THE SAFETY KEY AND BATTERY BEFORE PERFORMING ANY ADJUSTMENTS, MAINTENANCE, OR REPAIRS TO YOUR MOWER.**

### Troubleshooting Table

PROBLEM	CORRECTIVE ACTION
<i>The Motor fails to start with the Safety Key inserted, and the Control Bar depressed.</i>	<ul style="list-style-type: none"> <li>⇒ Check to make sure that you properly inserted the Safety Key and the green Status Indicator Light is ON.</li> <li>⇒ Check to see if the white Button on the Safety Key has popped up; if it has, then depress the Button to reset it.</li> <li>⇒ Check that you installed the Battery correctly and that the Battery is fully charged. The green Status Indicator Light should be ON. If not, replace with a fully charged Battery or recharge the Battery.</li> <li>⇒ Check to make sure the Power/Mode Switch is in the correct position.</li> <li>⇒ Make sure you follow the correct starting sequence of sliding the orange Start Knob to the left and squeezing the orange Control Bar.</li> <li>⇒ Possibly the Blade is obstructed. Remove the Safety Key and Battery, turn the Mower over, and check the Blade to make sure the Blade spins freely and is unobstructed.</li> </ul>
<i>The Mower stops while mowing (for reasons other than releasing the Control Bar).</i>	<ul style="list-style-type: none"> <li>⇒ The Battery has completely depleted its charge. Recharge the Battery fully or replace it with a fully charged Battery.</li> <li>⇒ The Mower was probably overloaded. If the Status Indicator Light is out, the Circuit Breaker inside the Safety Key has tripped to protect the Motor. Reset Breaker by pushing in the white Button in the Safety Key and restart the Mower.</li> <li>⇒ The grass may be too high for the cutting height. Raise the cutting height or narrow your cutting swath and try again.</li> <li>⇒ The Blade, Mower Deck, or Side Discharge Chute probably clogged with debris. Remove the Safety Key and Battery, turn the Mower over, and clean if necessary.</li> <li>⇒ The white Circuit Breaker Button in the Safety Key may not be pushed in fully. Reset it and try again.</li> <li>⇒ If the Mower bogs down or stalls in heavy grass, raise the cutting height, walk more slowly, or cut a narrower swath. If the grass is wet, let it dry before mowing.</li> </ul>
<i>Excessive vibration or noise.</i>	<ul style="list-style-type: none"> <li>⇒ The Blade may be loose. Remove the Safety Key and the Battery; turn the Mower over and check that the Blade is securely attached.</li> <li>⇒ The Blade may be unbalanced, bent, or damaged. Remove the Safety Key and Battery, turn the Mower over, remove the Blade, and check its condition. Replace with a new Blade if necessary.</li> </ul>

# **WARNING!**

**ALWAYS REMOVE THE SAFETY KEY AND BATTERY BEFORE PERFORMING ANY ADJUSTMENTS, MAINTENANCE, OR REPAIRS TO YOUR MOWER.**

<b>PROBLEM</b>	<b>CORRECTIVE ACTION</b>
<i>The Mower runs, but the cutting performance is unsatisfactory, or there is a loss of power.</i>	<ul style="list-style-type: none"><li>⇒ The Battery was probably not at full charge prior to Mowing. Charge the Battery, if necessary.</li><li>⇒ The Blade may be dull, bent, loose or damaged. Remove the Safety Key and the Battery, turn the Mower over, and check the condition of the Blade. Sharpen, tighten, or replace the Blade, if necessary.</li><li>⇒ The grass may be too high or too thick for the cutting height. Raise the cutting height or narrow your cutting swath and try again.</li></ul>
<i>The Mower is hard to push.</i>	<ul style="list-style-type: none"><li>⇒ The grass may be too high or too thick for the cutting height. Raise the cutting height or narrow your cutting swath and try again.</li><li>⇒ The Wheels may not be rotating freely. Remove the Safety Key and the Battery, turn the Mower over, and check the Wheels for damage.</li></ul>
<i>The Battery loses its charge quickly.</i>	<ul style="list-style-type: none"><li>⇒ The Battery was probably not at full charge prior to Mowing. Charge the Battery, if necessary.</li><li><b>NOTE:</b> <i>You will need to charge a new Battery at least five (5) times to achieve maximum cutting time.</i></li><li>⇒ The grass may be too high or too thick for the cutting height. Raise the cutting height or narrow your cutting swath and try again.</li><li>⇒ The Battery may be getting old. After some time, usually about five (5) years, you will need to replace the Battery.</li></ul>
<i>The Mower rear Bagger is collecting grass poorly.</i>	<ul style="list-style-type: none"><li>⇒ The rear Bagger is full. Empty the Bagger, and clean it if necessary.</li><li>⇒ The grass is too long or the Mower is cutting too low. Raise the cutting height.</li><li>⇒ The Mower is moving too fast, slow down.</li><li>⇒ The mesh holes in the rear Bagger are clogged, clean them out.</li><li>⇒ The rear Bagger is wet. Allow it to dry thoroughly before using it again.</li></ul>

## Troubleshooting Table - continued

PROBLEM	CORRECTIVE ACTION
<p><i>The Battery LED does not turn RED when the Charger is connected.</i></p>	<p>⇒ Unplug the Battery Charger from your standard 110V wall outlet and from the Charger Receptacle on the Battery. Inspect the Battery Charger for any visible signs of damage to the body and the cord. If you observe damage to the Battery Charger, please discontinue use.</p> <hr/> <p><b>⚠ WARNING!</b></p> <p>Use of a damaged Battery Charger may cause a short circuit and the potential for a fire.</p> <hr/> <p>⇒ Inspect the Charger Receptacle on the Battery for any signs of visible damage or debris. If there is debris present, please use caution to remove the debris.</p> <hr/> <p><b>⚠ WARNING!</b></p> <p>Do not remove the debris with any metallic objects, damp or flammable items, or items that may become lodged in the Charger Receptacle as this may cause a fire, or explosion of the Battery. If you observe damage to the Charger Receptacle, please discontinue use.</p> <hr/> <p><b>TIP</b> → Use a vacuum equipped with a non-metallic nozzle to remove debris from the Charger Receptacle on the Battery.</p> <p><b>NOTE:</b> <i>You can damage the Charger Receptacle by excessive force. It should not take a great amount of force to insert the round Charger Connector. Please do not force the round Charger Connector into the Charging Receptacle on the Battery.</i></p>
<p><i>The Battery Charger LED does not come on when plugged into a standard 110V wall outlet.</i></p>	<p>⇒ Unplug the Battery Charger from your standard 110V wall outlet and from the Charger Receptacle on the Battery. Inspect the Battery Charger for any visible signs of damage to the body and the cord. If you observe damage to the Battery Charger, please discontinue use.</p> <hr/> <p><b>⚠ WARNING!</b></p> <p>Use of a damaged Battery Charger may cause a short circuit and the potential for a fire.</p> <hr/> <p>⇒ Verify your Standard 110V wall outlet is functioning correctly by plugging a lamp or other electrical device into the same socket on the wall outlet you are intending to use.</p>

***NOTES:***



# Chapter 9: Optional MA 3.6 Trimmer and MA 5.6 Striper Roller

This chapter explains the safe operation, use, and maintenance of the MA 3.6 Trimmer and MA 5.6 Striper Roller. Please read this entire chapter before attaching and using the Trimmer and Striper Roller.

## Safety and Information Labels

You will find the following labels on the Trimmer

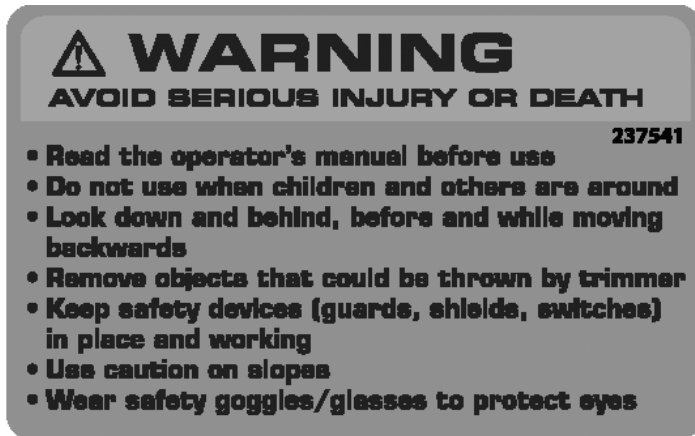

Warning and Safety Instructions label (237541)

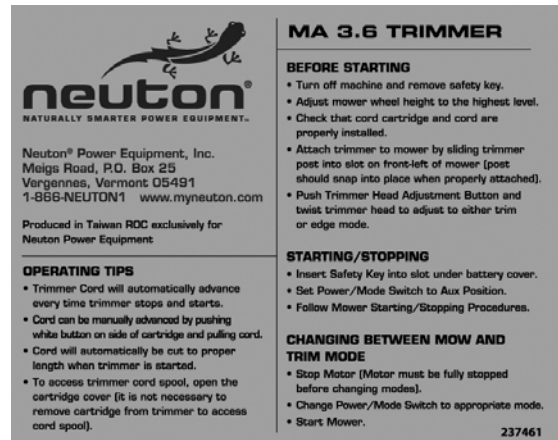

Operating Instructions label (237461)



Danger label (224581)

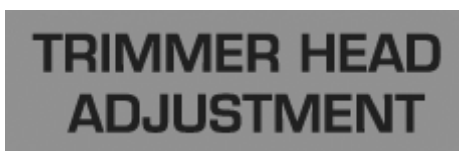

Head Adjustment label (237481)



Release label (237471)

# Operating Your Trimmer Safely

Before operating your Trimmer, please review “Chapter 2: Important Safety Considerations”.

## Trimming on Slopes Safely

Slopes are a major factor related to slip-and-fall accidents, which can result in severe injury. All slopes require caution. If you feel uneasy on a slope, do not trim or edge it.

*Always:*

- Use caution on slopes. Whenever possible, trim or edge across the face of slopes, not up and down. Exercise caution when changing direction on slopes.
- Remove objects such as rocks and tree limbs, or any other potential object possibly thrown by the Cutting Cord. Objects struck by the Cord can cause severe injuries.
- Watch for holes, ruts, or bumps. Tall grass can hide obstacles.

*Never:*

- *Never* trim or edge near drop-offs, ditches, or embankments. You could lose your footing or balance.
- *Never* trim or edge steep slopes or any other areas where stability or traction is in doubt.
- *Never* trim or edge on wet grass. Unsure footing could cause you to slip.

## Using the NEUTON Trimmer

The NEUTON Trimmer (powered by your NEUTON Mower) is a versatile machine that quickly and easily attaches to the front of the Mower (**Figure 31**) to trim and edge your lawn without your having to buy both a separate Trimmer and Edger. The Trimmer can cut an eleven (11) inch swath through lawn grass and light weeds.

The NEUTON Trimmer ships fully assembled and ready to use. Also included are two (2) replacement Cord Spools for the Trimmer.



**Figure 31**

# Attaching, Removing and Using the Trimmer

Attaching and removing the Trimmer is quick and easy.

## **WARNING!**

**ALWAYS REMOVE THE SAFETY KEY BEFORE ATTACHING, REMOVING, OR ADJUSTING THE TRIMMER.**

## Attaching the Trimmer

1. Adjust the Mower Cutting Height Lever to position 4; this sets the Cutting Height to the highest level.
2. Insert the Trimmer post into the Trimmer Port in the front of the Mower (**Figure 32**). The Post will snap into place when fully inserted.

**TIP**

Hold the Mower so that it will not roll (**Figure 32**) when inserting the Trimmer.

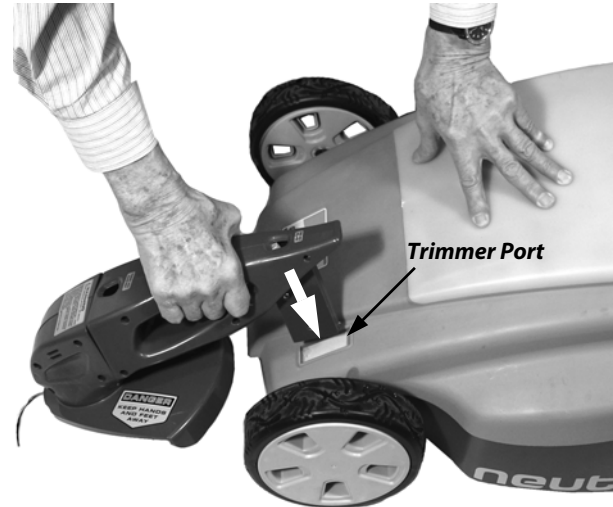

Figure 32

## Removing the Trimmer

Push in the Trimmer Release Button (**Figure 33**) and pull the Trimmer up and out of the Trimmer Slot in the Mower. Once it has started to pull out, you can release the Button.

**TIP**

Hold the Mower (**Figure 32**) so that it will not roll when removing the Trimmer.

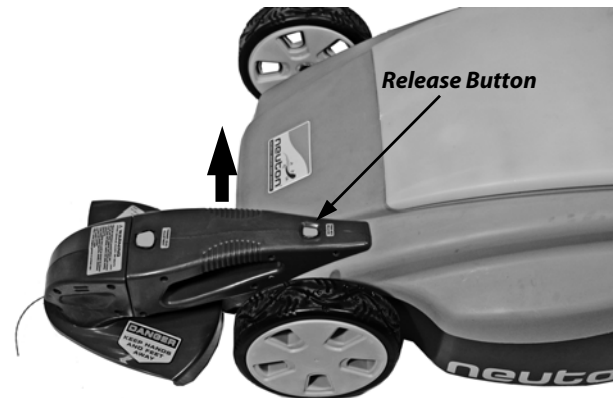

Figure 33

# Adjusting the Trimmer Head

Before adjusting the Trimmer, you must first decide to Edge or Trim your lawn.

To set the Trimmer Head for edging or trimming, push in the Trimmer Head Adjustment Button on top of the Trimmer and rotate the Trimmer Head to the Trim or Edge position (**Figure 34** or **35**) until the Head snaps into position.



**Trim Position**

**Figure 34**

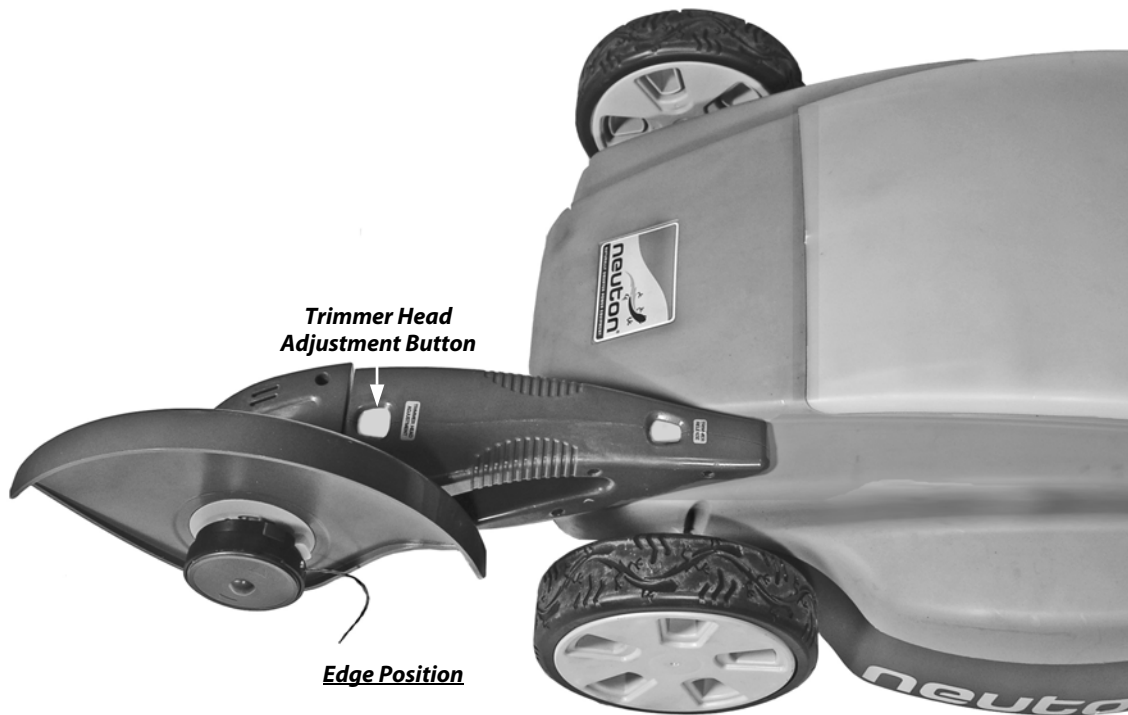

**Edge Position**

**Figure 35**

## Starting the Trimmer

The Battery in the NEUTON Mower powers the Trimmer, making the cutting cord spin. Make sure the Battery has a full charge before you begin.

### NOTICE

- **STARTING, STOPPING, AND RESTARTING AN ELECTRIC MOTOR REPEATEDLY WITHIN A FEW SECONDS CAN GENERATE A GREAT DEAL OF HEAT AND DAMAGE THE MOTOR. TO PROTECT THE LIFE OF YOUR NEUTON TRIMMER, ALWAYS WAIT AT LEAST FIVE (5) SECONDS AFTER STOPPING BEFORE RESTARTING THE TRIMMER.**
- **THE CUTTING CORD ALWAYS TURNS WHEN THE MOTOR IS RUNNING; THERE IS NO CLUTCH TO ALLOW THE CORD TO STOP ROTATING WHILE THE MOTOR IS RUNNING.**

1. Set the Power/Mode Switch to Auxiliary (**Figure 18** on page 19).

**NOTE:** *The Cutting Blade on the Mower does not turn when the Power/Mode Switch is in the Auxiliary position.*

2. Insert the Safety Key into the Key Slot. The green Status Indicator Light should come ON.

3. Slide the orange Start Knob to the left and then squeeze and hold the orange Control Bar (**Figures 22 & 23** on page 25). The Trimmer motor will now start and run for as long as you are squeezing the Control Bar.

## Stopping the Trimmer

Simply release the Control Bar to Stop the Trimmer.

### NOTICE

**THE TRIMMER WILL CONTINUE TO ROTATE FOR A COUPLE OF SECONDS AFTER YOU RELEASE THE CONTROL BAR. WAIT FOR THE MOTOR TO STOP BEFORE MOVING THE MOWER. REMEMBER TO WAIT AT LEAST FIVE (5) SECONDS AFTER STOPPING BEFORE YOU RESTART THE TRIMMER MOTOR.**

When you are finished trimming or edging, remember to remove the Safety Key.

## Advancing the Cord

Each time the Trimmer starts or comes to a complete stop, the Trimmer's Cutting Cord automatically advances and cuts itself to 5-1/2" resulting in an eleven (11) inch cutting swath.

You can also manually advance the Cord.

1. Release the orange Control Bar to stop the Trimmer motor and remove the Safety Key.
2. Push in the white Button on the side of the Spool Housing (**Figure 36**) and pull the Cord to advance it. The Cord advances in small increments so you might have to push the Button a few times.

**NOTE:** Try not to advance the Cutting Cord past the Trimmer Shield. If you do pull out too much Cord, the Cutter on the Trimmer Shield automatically trims the length of the Cord (**Figure 37**).

### **WARNING!**

**BE CAREFUL, THE EXCESS CORD WILL FLY OFF WHEN YOU START THE TRIMMER AND COULD BE DANGEROUS.**

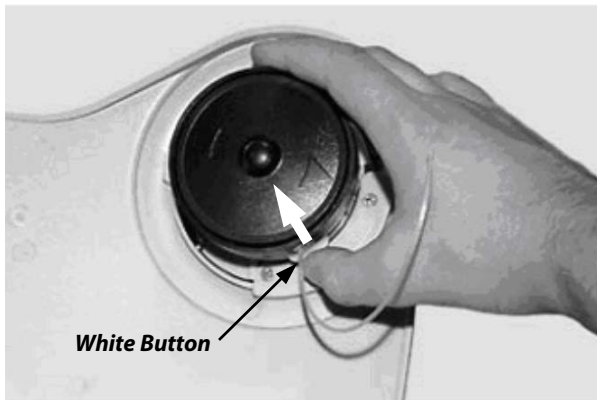

Figure 36

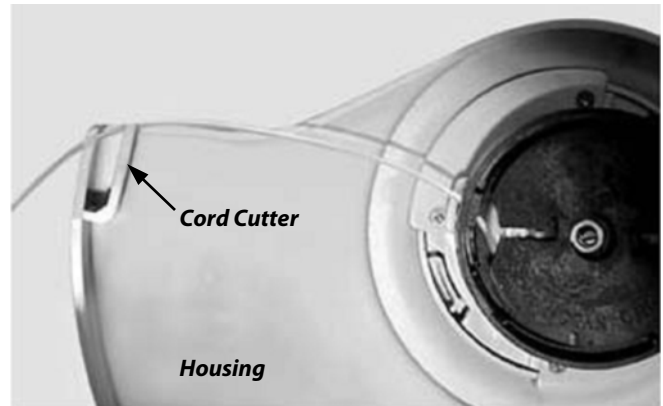

Figure 37

## Safety Tips for using the Trimmer

Following these tips will provide safe operation and enhance the performance of your Trimmer:

- Always stop the motor before toggling the Power/Mode Switch.
- You can adjust the cutting height of the Trimmer by raising or lowering the Mower's cutting height level. Make sure you first stop the motor and remove the Safety Key before changing the height.
- Stop the motor and remove the Safety Key before changing the position of the Trimmer Head.
- The Battery will drain more quickly in the Edger mode. You can realistically expect up to 45 minutes of use in the Edger mode, and approximately one (1) hour in Trim mode. This is when having an extra charged Battery comes in handy. Be sure to remove the Safety Key when you change the Battery.
- Be sure to clean the Trimmer Head frequently keeping the cooling vents and air intake holes free of debris.

# Maintaining and Storing the NEUTON Trimmer

This section explains how to clean and store the Trimmer, replace the Spool, and change the Spool Housing.

## **WARNING!**

**ALWAYS REMOVE THE SAFETY KEY BEFORE REMOVING THE TRIMMER FROM THE MOWER, PERFORMING ANY ADJUSTMENTS, MAINTENANCE, SPOOL CHANGES, OR REPAIRS TO THE TRIMMER. ALLOW THE TRIMMER TO COOL AT LEAST FIVE (5) MINUTES BEFORE SERVICING OR STORING.**

## Replacing the Spool

Replace the Spool when the Cord runs out.

1. Using two (2) fingers, press the Clips on the side of the Spool Housing (**Figure 38**) and push them UP slightly towards you. The green Cover will pop up part way and then remove it. The outer black Spool Housing stays on the Trimmer.
2. Lift out the empty Spool.
3. Thread the end of the new Cord through the metal opening in the Spool Housing.
4. Insert the new Spool with the printed side facing out (so you can read it).

### **TIP**

Try gently pulling on the Cord to help seat the new Spool.

5. Replace the green Cover. Make sure the Clips (1 each side) in the Cover align with the Slots in the Spool Housing. If they don't, press the Clips and turn the Spool Housing until the Clips and Slots align. The Clips must snap securely into place.

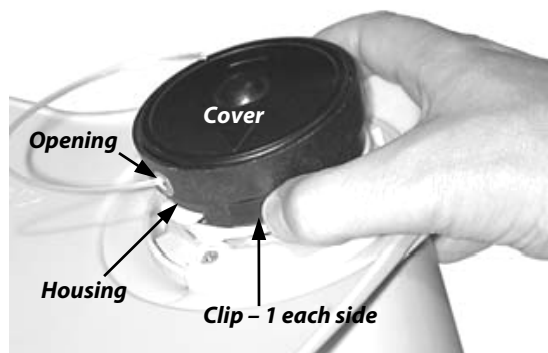
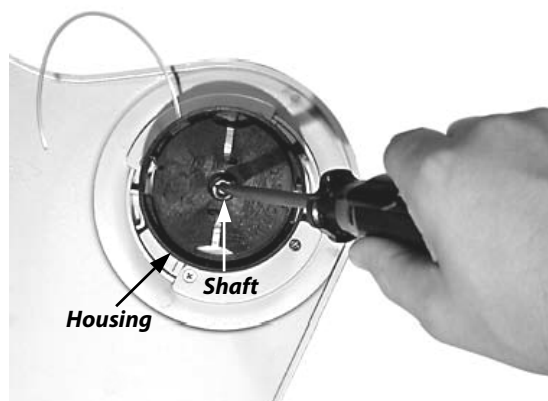

**Figure 38**

## Replacing the Spool Housing

You only need to replace the Spool Housing if it is damaged or cracked. You do not need to remove the Shield to replace the Spool Housing. If the Cord runs out, only change the Spool.

1. Remove the green Spool Cover. See "Replacing the Spool" for details.
2. Using a flat-head Screwdriver, hold the Shaft in place (**Figure 39**) so it won't turn and unscrew (counterclockwise) the Spool Housing with your hand and remove it.
3. Install a new Spool Housing in the reverse order and securely tighten by hand.



**Figure 39**

## Cleaning the Trimmer

Periodically clean the Trimmer to ensure peak performance.

### Supplies Needed:

- Clean, damp cloth or sponge
  - Mild soap or detergent (if needed)
  - Soft nylon brush (if needed)
1. Remove the Safety Key and remove the Trimmer from the Mower.
  2. Using a damp cloth or sponge with a mild soap or detergent, clean the Trimmer. Never use water, gasoline, solvents, or other petroleum-based or solvent-based products when cleaning – remember that this is an electric Trimmer.
  3. Use a soft nylon brush or non-metallic scrubbing pad to remove any clippings that have accumulated on the Trimmer and underside of the Trimmer Shield. Do not use a wire brush; it will scratch and harm the surface of your Trimmer.
  4. Remove any grass or weeds that might have wound around the Spool.
  5. Store the Trimmer indoors in a dry place and out of the reach of children.

## Attaching and Using the Striper Roller

### **WARNING!**

**ALWAYS REMOVE THE SAFETY KEY BEFORE ATTACHING OR REMOVING THE STRIPER ROLLER.**

The Striper Roller (**Figure 40**) easily attaches with Hooks into pre-formed Slots (one each side) at the rear of the NEUTON Mower (**Figure 41**). You can use either the Bagger attachment (recommended) or the Mulching Plug (but not the Side Discharge Chute) with the Striper Roller.

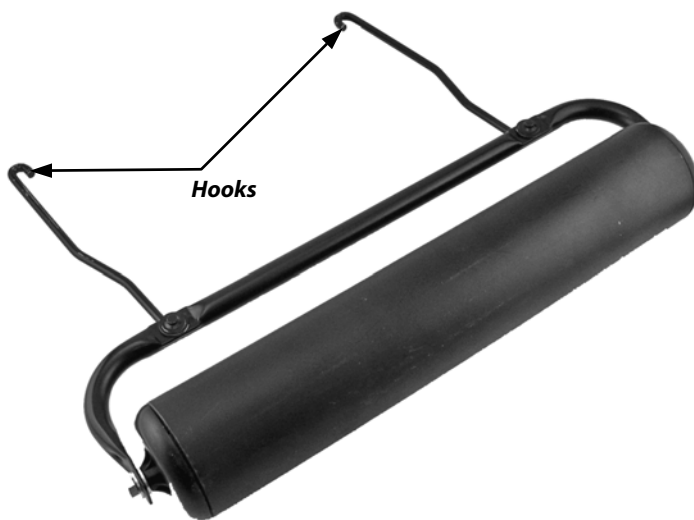

**Figure 40**

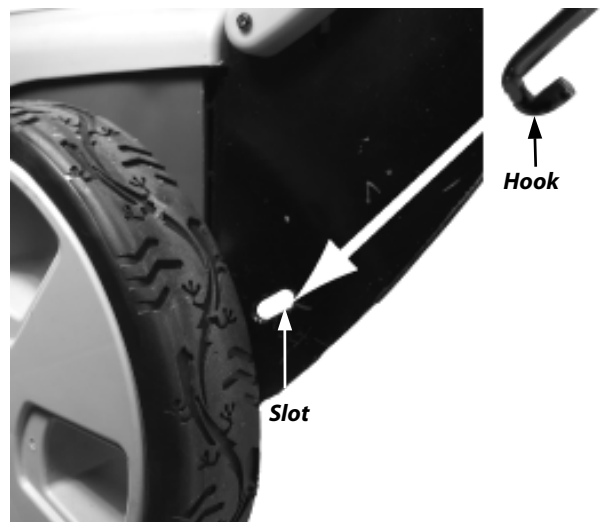

**Figure 41**



### Tool and Supplies Needed:

- Bag of fine sand
- Funnel
- Hammer (optional)

1. Install one (1) of the two (2) End Caps (found in a plastic bag stapled around a Hook Arm) in one end of the Roller (**Figure 42**).

**TIP** → The End Cap fits snugly so you may have to gently tap it in with a Hammer.

2. Stand the Roller on the end with the End Cap installed and fill the Roller through the opposite hole in the Roller with fine sand using a Funnel and then install the second End Cap.
3. Insert the Hooks into the Slots provided at the rear of the Mower (**Figure 41** on the previous page).

**TIP** → For ease of inserting the Hooks, hold the Roller Arms up against the Handlebars.

4. After inserting the Hooks, lower the Striper Roller to the ground (**Figure 43**), attach the Bagger or insert the Mulching Plug, and simply create the lawn pattern of your choice as you mow!

**TIP** → See **Figure 45** on the next page for some examples of lawn patterns you can create with your new Striper Roller.



**Figure 42**



**Figure 43**

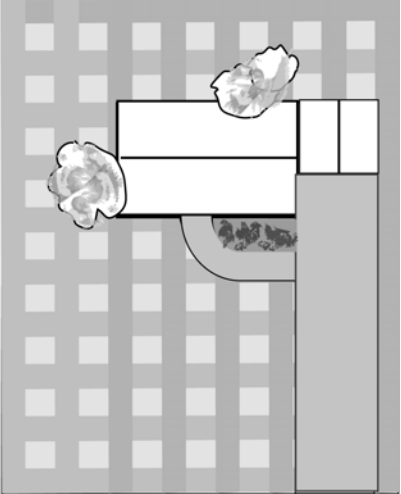
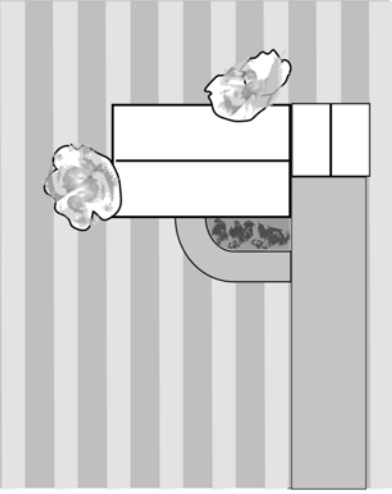
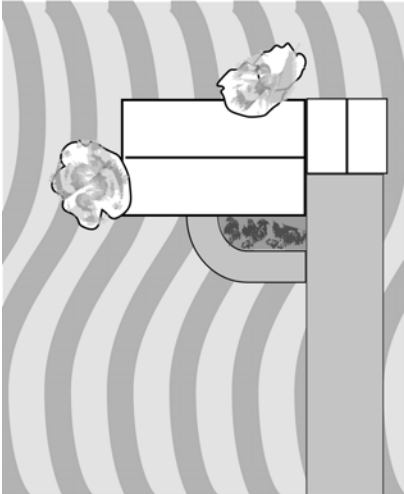
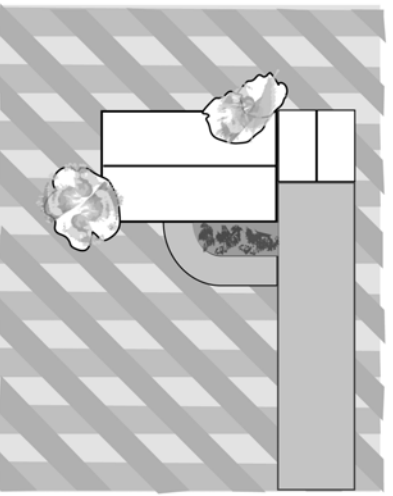
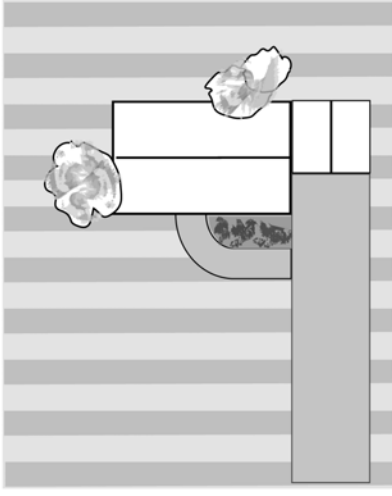
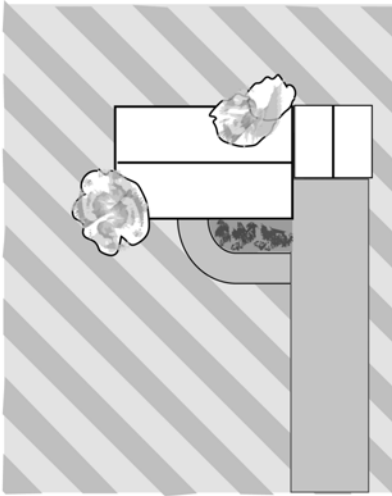

Figure 44

# Chapter 10: Parts Lists, Schematic Diagrams, and Warranty

## Parts List - NEUTON CE6.2 Mower

*NOTE: Part numbers listed are available through Neuton Power Equipment*

Item #	Description	Qty	Part #		Item #	Description	Qty	Part #
1	Spring, Battery Pack Cover (small)	1	240821		19	Base, Fixed, Trimmer Arm Support Cap	1	238371
2	Cover, Battery Pack	1	238401		20	Label, Height Adjustment	1	237491
3	Spring, Extension of Spring for Battery Pack Cover	2	238411		21	Label, Optimize Performance	1	237531
4	Pin, Battery Pack Cover (POM)	2	238421		22	Label, Battery Alignment	1	196021
5	Screw, 4mm x 16mm	10	196371		23	Base, Fixed, Push Button	1	238331
6	Wrench, 16mm	1	240841		24	Spring, 19mm, Length	1	238351
7	Wrench, 36mm	1	176281		25	Button, Push	1	238341
8	Screw, 5mm x 20mm, Housing	4	240131		26	Motor	1	238581
9	Arm, Battery	1	196441		27	Screw w/Washer, Contact	2	176111
10	Strap, Safety Key (orange)	1	206511		28	Wire, Red, #12, 250mm L, Battery	1	240911
11	Key, Safety	1	175931		29	Screw, 4mm x 16mm	6	243701
12	Label (Operating Instructions)	1	237381		30	Wire, Black, #16, 460mm L, Trimmer	1	240921
13	Label (Safety Key)	1	237501		31	Wire, Red, #16, 470mm L, Trimmer	1	240931
14	Label (Neuton Badge)	1	210531		32-34	Circuit Board and Relay Assy	1	238621
15	Housing, Upper	1	238321		32	Relay, Trimmer	1	
16	Pin, Spring	1	238381		33	Relay, Mower	1	
17	Spring, 18.5mm, Length	1	238391		34	Circuit Board	1	
18	Cap, Trimmer Arm Support	1	238361		35	Wire, Black, #12, 380mm L, Battery	1	240901

Item #	Description	Qty	Part #		Item #	Description	Qty	Part #
36	Contact, Electrical, CU Connector	2	176101		53	Spring, Extension	1	240971
37	Nut	2	240941		54	Nut, Connector	4	176411
38	Screw	1	240141		55	Axle, Rear	1	238721
39	Washer	1	196701		56	Plate, Rear Axle, Metal (Right)	1	238781
40	Label, Serial Number	1			57	Plate, Front Axle, Metal	4	238691
41	Deck, Lower, Mower	1	238571		48,58 67-69	Right Rear Wheel Replacement Kit	1	250071
42	Plate, Mounting, Motor	1	175971		48	Cap, Hub, Wheel	1	240981
43	Screw w/3mm Lock Washer	4	175981		58	Wheel, Rear, Right, Assembly	1	238701
44	Adapter, Blade	1	196731		67	Bearing, POM	2	243711
45, 47	Blade, Aero Cutting, MA 6.2	1	243161		68	Washer, Flat	2	176321
45	Blade, Aero	1			69	Nut, Axle	1	176331
46	Adapter, Hex	1	196671		59	Screw, 5mm x 20mm, Hex	1	240961
47	Nut w/Flange, Blade	1	243611		60	Cap, Upper, Height Adjustment Knob	1	240951
48,49 67-69	Left Rear Wheel Replacement Kit	1	238791		61	Knob, Height Adjustment	1	238761
48	Cap, Hub, Wheel	1	240981		62	Rod, Connecting, Front	1	238731
49	Wheel, Rear, Left, Assembly	1	238711		63	Rod, Height Adjustment	1	238751
67	Bearing, POM	2	243711		64, 67-70	Right Front Wheel Replacement Kit	1	269281
68	Washer, Flat	2	176321		64	Wheel Assembly, Front, Right	1	238631
69	Nut, Axle	1	176331		67	Bearing, POM	2	243711
50	Plate, Rear Axle, Metal (Left)	1	238771		68	Washer, Flat	2	176321
51	Screw, 4mm x 16mm	12	196371		69	Nut, Axle	1	176331
52	Rod, Connecting, Rear	1	238741		70	Cap, Wheel, Front	1	238651

Item #	Description	Qty	Part #		Item #	Description	Qty	Part #
65	Axle, Front	1	238681		82	Bar, Control, Orange	1	
66-70	Left Front Wheel Replacement Kit	1	269291		83	Spring, Control Bar	2	
66	Wheel Assembly, Front, Left	1	238641		84	Screw, 4mm x 6mm	1	
67	Bearing, POM	2	243711		85	Spring, Extension, Start Knob	1	
68	Washer, Flat	2	176321		86	Screw, 4mm x 16mm	2	
69	Nut, Axle	1	176331		87	Internal Control Bar Fixed Piece	1	
70	Cap, Wheel, Front	1	238651		88	Housing, Upper Handlebar, Bottom	1	
71-90	Upper Handlebar Assembly	1	238671		89	Screw, 3.5mm x 20mm	14	
71	Label, Handlebar (Right)	1	237401		90	Label, Serial Number	1	
72	Label, Handlebar (Left)	1	237391		91	Battery Charger	1	243791
73	Label, Transparent Light Cover	1	196931		92	Label, Battery Charger (Warning)	1	237521
74	Housing, Upper Handlebar, Top	1			93	Label, Battery Operating Tips	1	237441
75-77	Switch Assembly	1			94	Battery Pack	1	243061
75	Indicator, Power	1			95	<i>Safety &amp; Operating Instructions Manual</i>	1	240481
76	Switch, Mow/Aux, Orange	1			96 - 117	Lower Handlebar Assembly	1	250061
77	Cable, Switch w/Indicator Light	1			96	Screw, 6mm x 25mm	4	
78	Screw, 4mm x 10mm	1			97	Guard, Discharge	1	
79	Cable, Main	1			98	Label, Discharge Guard (DANGER)	1	176701
80	Handlebar Steel Tube w/Gear	1			99	Label, Discharge Guard (WARNING)	1	237371
81	Knob, Start, Orange	1			100	Screw, Rivet, 8mm x 18mm L	2	

Item #	Description	Qty	Part #		Item #	Description	Qty	Part #
101	Washer, Lock w/Cap	2			120	Mesh, Bagger	1	240071
102	Guide, Cable	1			121	Flap, Rear	1	238601
103	Nut, Connector, Small	2			122	Bar, Rear Flap	1	238611
104	Nut, Connector, Big	2			123	Plug, Mulching	1	238811
105	Button, Height Adjustment of Handlebar Right	1			124 – 126	Chute, Discharge	1	238821
106	Spring, Height Adjustment Button Right	1			124	Handlebar, Chute	1	238841
107	Label, WARNING, Pinch Point	2			125	Chute (only)	1	238831
108	Plate, Steel for Fixed Handlebar Right	1			126	Screw, 4mm x 16mm	1	243701
109	Washer, Flat	2			127 – 136	Striper Roller	1	238861
110	Washer, Flat	2			127	Hook, Steel, Right	1	240991
111	Rivet, 28.7mm Long	2			128	Washer, Flat	2	240891
112	Gear, Ratchet	2			129	Nut, Connector	2	176411
113	Bar, Rear Discharge for Bagger and Chute	1			130	Rivet of Steel Tube	2	241001
114	Spring, Discharge Guard	1			131	Cap, End	2	241011
115	Plate, Steel for Fixed Handlebar Left	1			132	Cap, Side	2	238881
116	Spring, Height Adjustment Button Left	1			133	Washer, Flat	2	176321
117	Button, Height Adjustment of Handlebar Left	1			134	Roller	1	238871
118 - 120	Bagger Assembly	1	243121		135	Tube, Steel	1	238891
118	Frame, Steel, Bagger	1	238801		136	Hook, Steel, Left	1	238901
119	Label, Bagger	1			137	Sharpener, Blade (optional)	1	226921

# Schematic Diagrams - NEUTON CE6.2 Mower

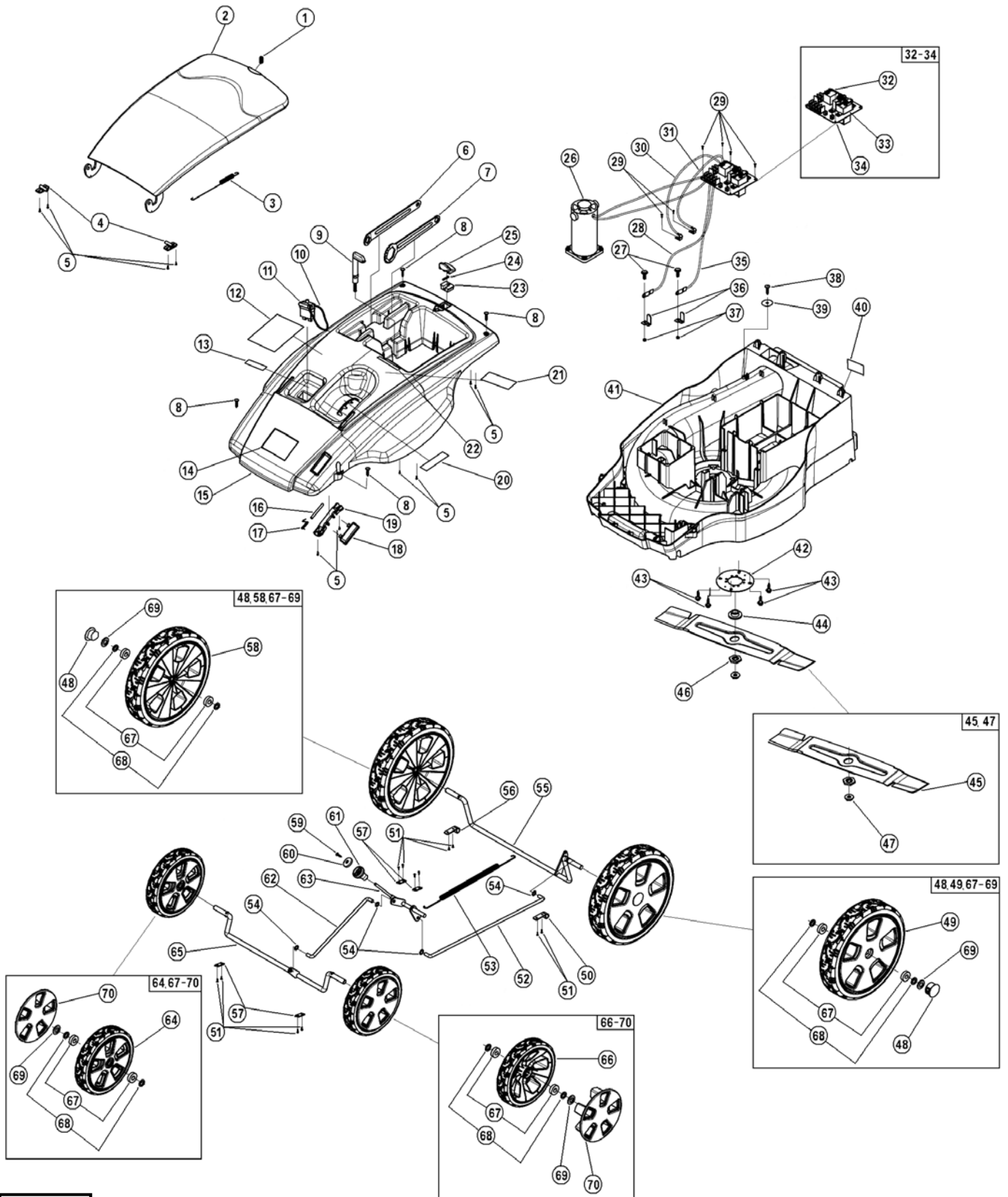

080111

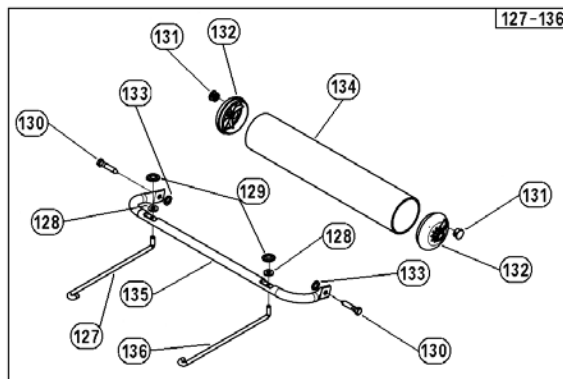
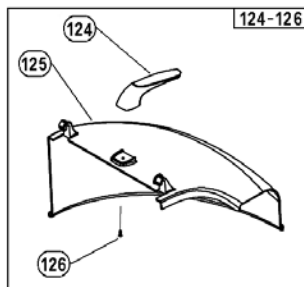
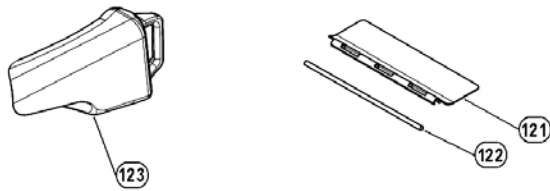
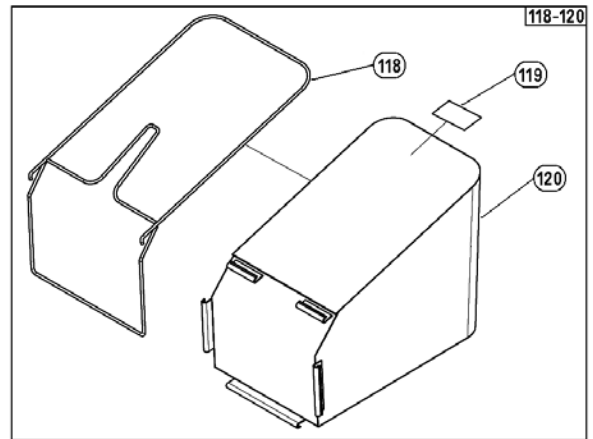
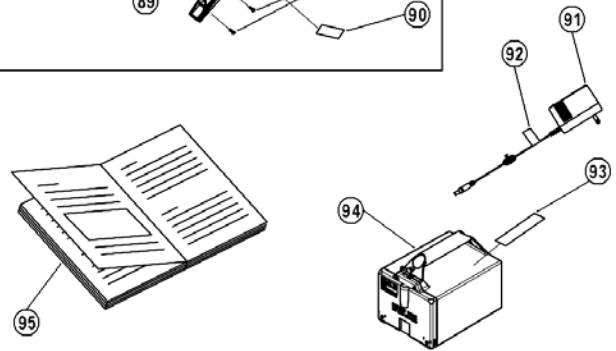
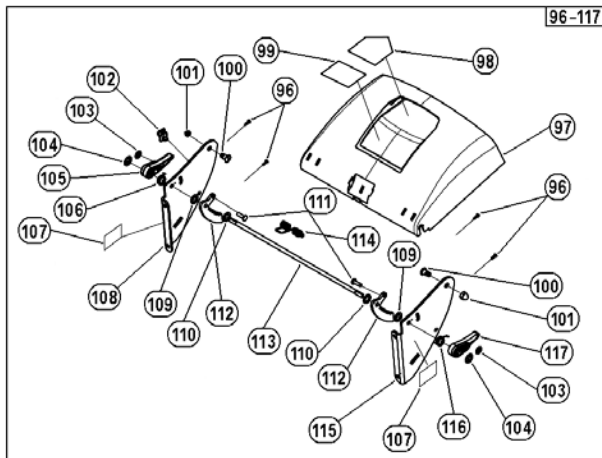
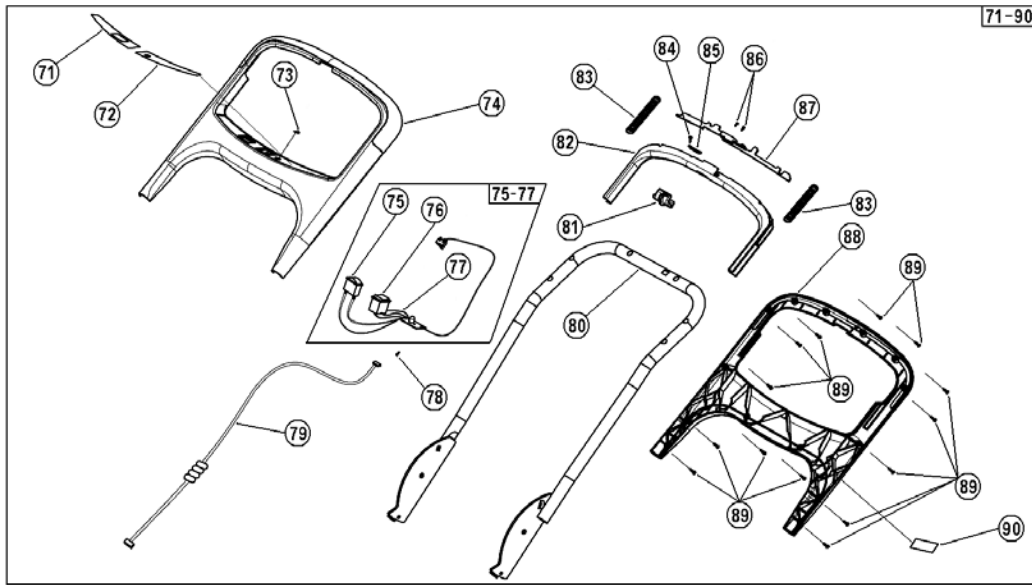

**080111**



# Parts List - Optional MA 3.6 Trimmer

*NOTE: Part numbers listed are available through Neuton Power Equipment*

Item #	Description	Qty	Part #
1	MA 3.6 Trimmer w/o Cutter Head	1	240101
2 - 4	Cutter Head Assembly	1	177051
2	Housing, Cartridge	1	195891
3	Spool w/Cord	1	177221
4	Cover, Spool Housing, Green	1	195911

## Schematic Diagram - Optional MA 3.6 Trimmer

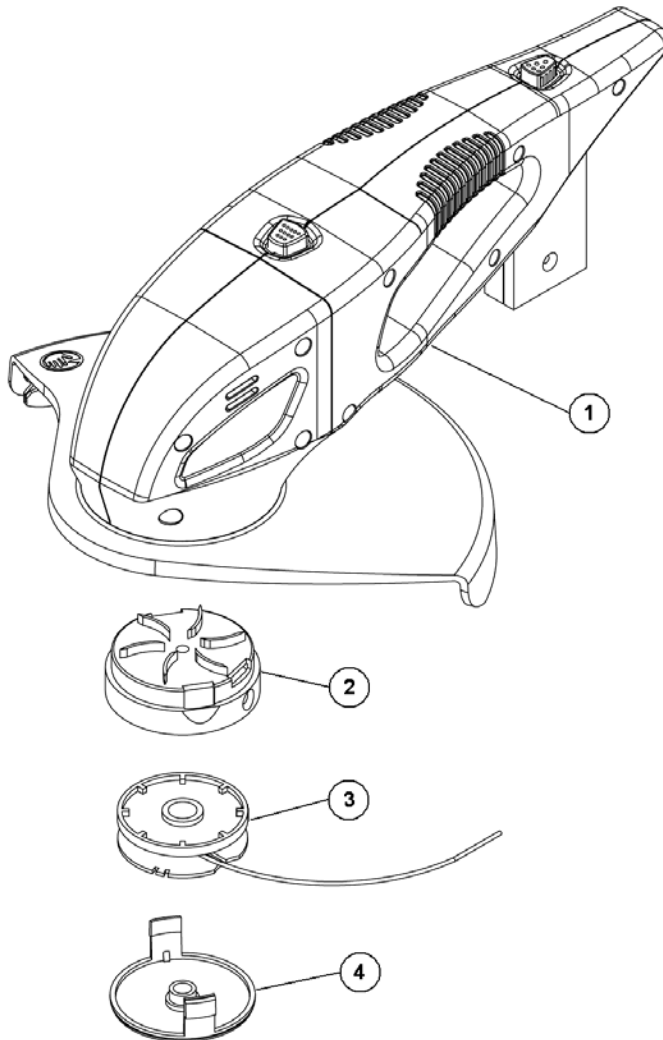

***NOTES:***

# 2-Year Limited Warranty

## Terms and Conditions

The NEUTON® CE6.2 Battery-Powered Mower is warranted for two (2) years, one (1) year for the NEUTON® Attachments and Accessories, against defects in materials or workmanship when put to personal residential household use.

For the purposes of the warranty, "personal residential household use" refers to non-commercial residential use and further excludes misuse, accidents, or damage due to inadequate maintenance.

Neuton Power Equipment certifies that the NEUTON® CE6.2 Battery-Powered Mower is fit for ordinary purposes for which a product of this type is used. Neuton Power Equipment however, limits the implied warranties of merchantability and fitness in duration to a period of two (2) years, one (1) year for the NEUTON® Attachments and Accessories, in personal residential household use.

The 2-Year Limited Warranty on the NEUTON® CE6.2 Battery-Powered Mower, one (1) year for the NEUTON® Attachments and Accessories, starts on the date the machine shipped from our factory. The 2-Year Limited Warranty, one (1) year for the NEUTON® Attachments and Accessories, is applicable only to the original owner.

The owner is responsible for the performance of all the required maintenance as defined by the manufacturer's owner manual.

The owner is responsible for the replacement of normally wearing parts including the Blade, Battery, and the Bagger Mesh for the Mower and the Cord Spool and Spool Housing for the Trimmer. The Battery carries a one (1) year limited warranty.

During the warranty period, the owner is responsible for all shipping and transportation charges, if required.

SOME STATES DO NOT ALLOW LIMITATIONS ON THE LENGTH OF IMPLIED WARRANTIES, SO THE ABOVE LIMITATIONS MAY NOT APPLY TO YOU.

Neuton Power Equipment shall not be liable under any circumstances for any **incidental or consequential damages or expenses** of any kind, including, but not limited to, cost of equipment rentals, or cost of hiring services to perform tasks normally performed by the NEUTON® CE6.2 Battery-Powered Mower or the NEUTON® Attachments and Accessories.

SOME STATES DO NOT ALLOW THE EXCLUSION OR LIMITATION OF INCIDENTAL OR CONSEQUENTIAL DAMAGES, SO THE ABOVE LIMITATIONS MAY NOT APPLY TO YOU.

## Technical Support Hotline

Neuton Power Equipment's objective is to have 100% satisfied customers. For that reason, we operate a 6-day-per-week Technical Support Department for our NEUTON® owners. You can access a Representative by visiting our website at [www.neutonpower.com](http://www.neutonpower.com) or by dialing our Toll-Free Hotline at **1-866-NEUTON1 (638-8661)**. The sole job of our well-trained and friendly folks is to ensure that you get any help you need in a timely fashion. They are there to answer all your questions including: (1) inquiries on any of the above warranties, (2) inquiries about replacement parts, and (3) your questions regarding service, maintenance, and operation.

THIS WARRANTY GIVES YOU SPECIFIC LEGAL RIGHTS, AND YOU HAVE OTHER RIGHTS, WHICH VARY FROM STATE TO STATE.

# Daily Checklist for your NEUTON Mower

To help maintain your NEUTON Mower for optimum performance, we recommend you follow this checklist each time you use your machine.

[ ] BATTERY: Make sure the Battery has a full charge.

[ ] CLEAN: Before inserting the Safety Key, inspect the Mower Blade and clean it to remove any debris (such as grass or twigs) that might be clinging to the Blade from its last use. For the best performance and longest life of the Blade, it is best to clean the Blade of any clinging debris after each use. Always follow the safety precautions when cleaning the Blade.

Make sure the Control Bar is clean and operating smoothly. See page 36.

[ ] NOISES: If you notice anything unusual, such as a vibration or odd sound, shut the Mower down immediately. Remove the Safety Key and, following all safety procedures, inspect the Mower Blade and underside of the Mower for any obstructions.

If you cannot find the cause of the problem or are uncertain what to do, then have the Mower inspected by a qualified repair shop before using it, visit our website at [www.neutonpower.com](http://www.neutonpower.com), or call Neuton Power Equipment Technical Support Department, Toll Free, at **1-866-NEUTON1 (638-8661)**.

[ ] MOWING: If you are uncertain whether the grass you want to cut is too long or thick for optimal cutting, raise the Blade Height and mow the yard in multiple passes, cutting it slightly shorter each time. It is best to mow more frequently, rather than let the grass become excessively long. For the best results, see "Mowing and Lawn Care Tips" in Chapter 4.

We hope you will enjoy many years of satisfied use with your NEUTON Mower.



**Director, Customer Relations**

This manual made from recycled paper and is recyclable.

**Neuton Power Equipment**

---

**75 MEIGS ROAD, VERGENNES, VERMONT 05491**

---

[www.neutonpower.com](http://www.neutonpower.com)

©2010 Neuton Power Equipment 240481B